

**18 NEW RETICLE PATTERNS**

**HANDBOOK OF**

# **STANDARD RETICLE PATTERNS**

**BY MANUFACTURER**

Compiled by  
**D. Andrew Kopas**  
Issued 10/22/05,  
Updated 5/10/2012  
Version 9

*Intended for Educational  
Purposes Only, Not for  
Commercial Sale or Use*



The purpose of this handbook is to aid military, law enforcement, and civilian precision shooters in the selection of the proper reticle pattern for their respective mission. Given the wide variety of different reticle patterns used by the various scope manufacturers represented herein, including most of them in a single document can help to simplify the selection process. The reader should verify the current status of the reticle with the manufacturer since some patterns may no longer be in production. Reticle patterns added in Version 9 include new additions from S&B, Horus, Night Force, Vortex, Super Sniper and others.

Special thanks to all of the rifle scope and reticle manufacturers listed at the end of this handbook for the reticle pattern schematics illustrated in this compilation.

# Schmidt and Bender Reticle Patterns

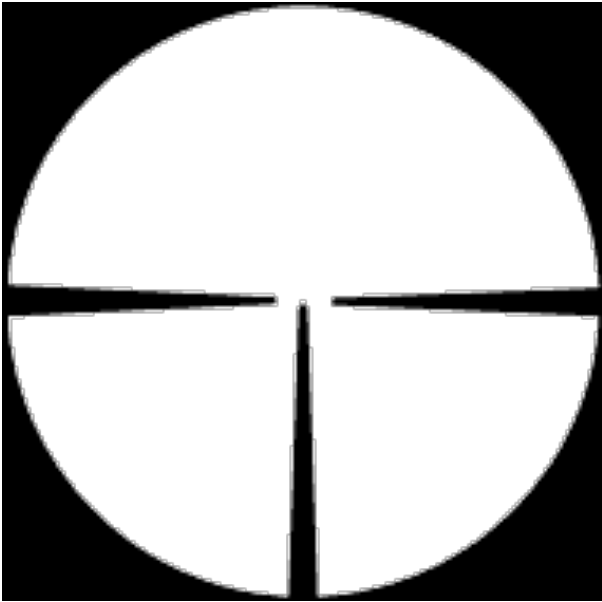

**Reticle No. 1**  
Fixed power only

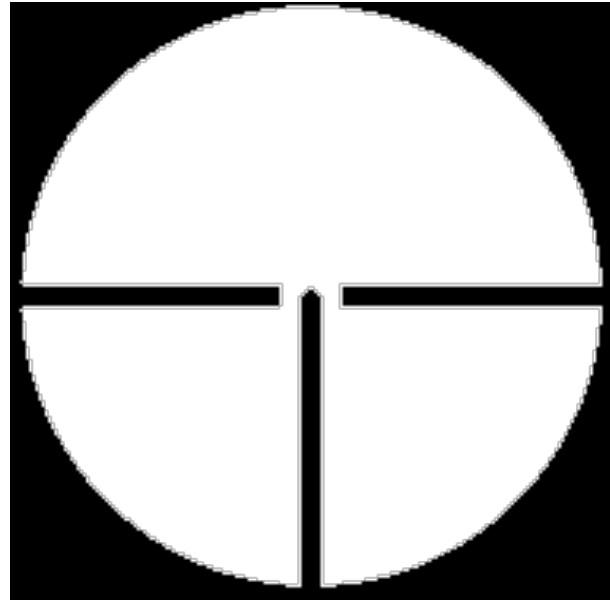

**Reticle No. 1**  
Variable power only

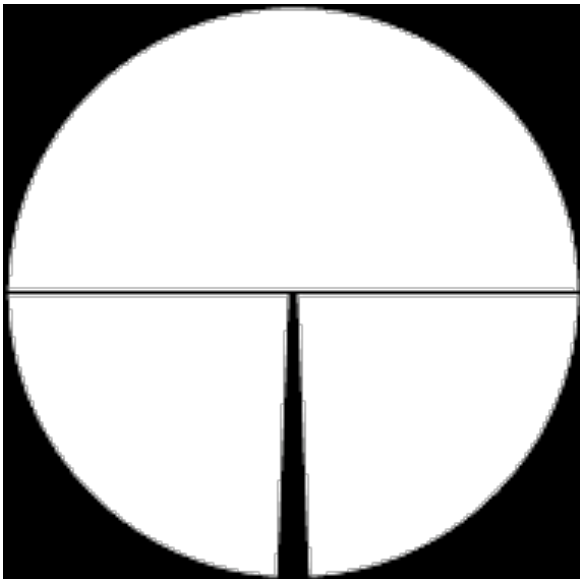

**Reticle No. 2**

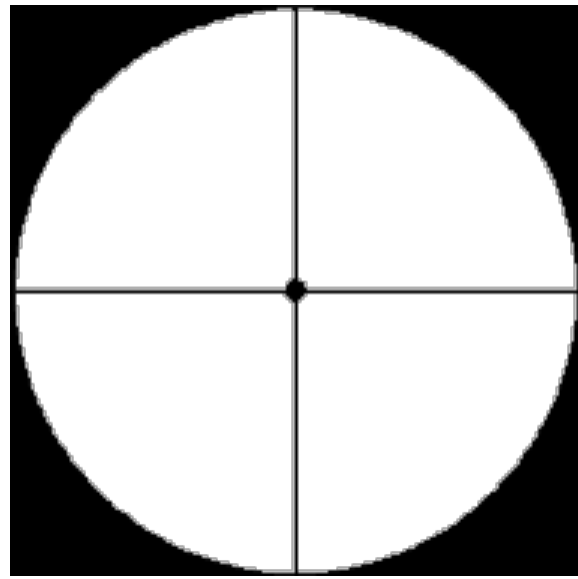

**Reticle No. 3**

# Schmidt and Bender Reticle Patterns

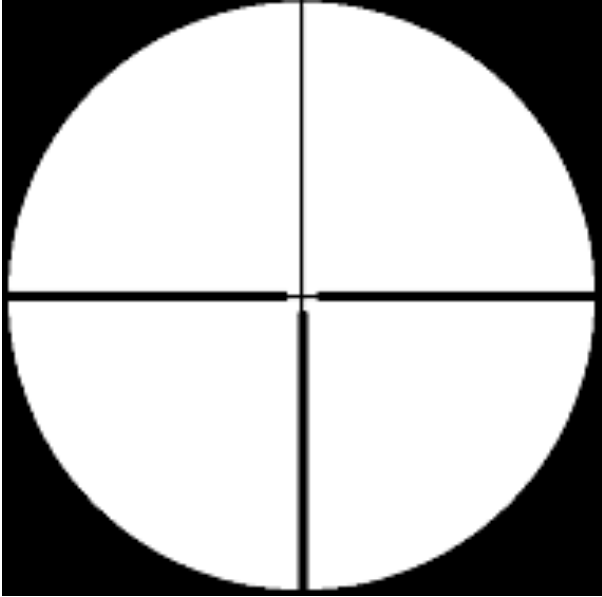

Reticle No. 4

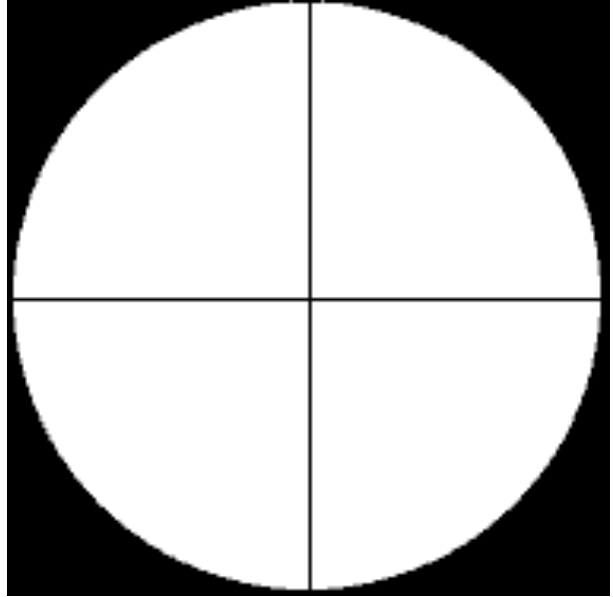

Reticle No. 6 fine (varmint)

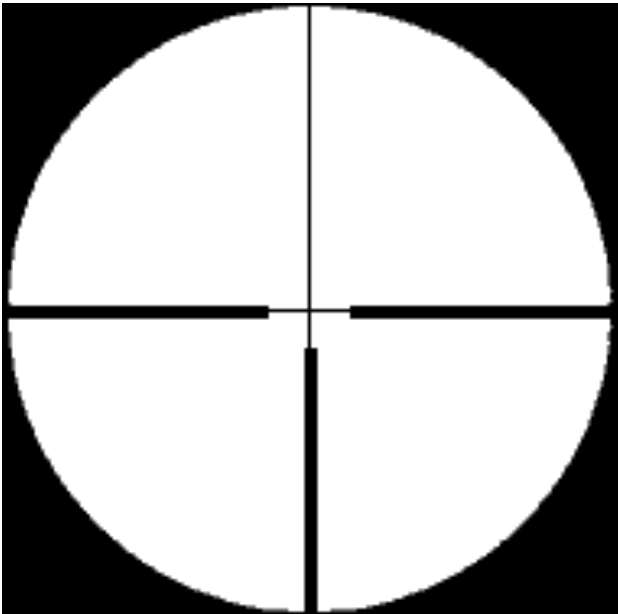

Reticle No. 7

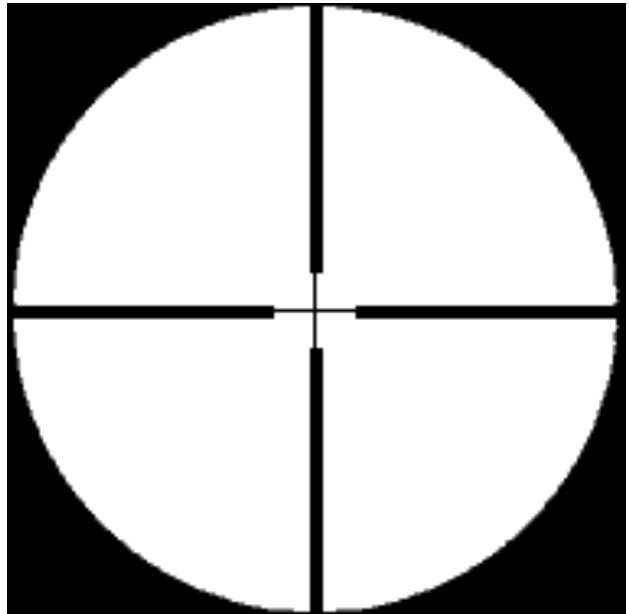

Reticle No. 8

# Schmidt and Bender Reticle Patterns

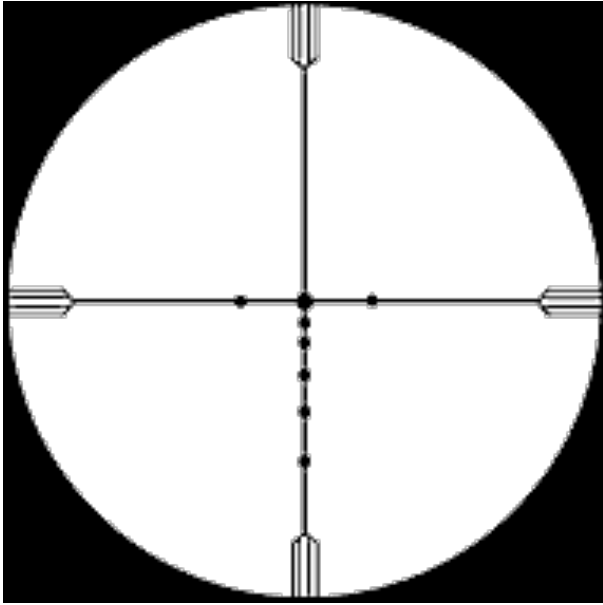

Reticle No. 8 Dot (varmint)

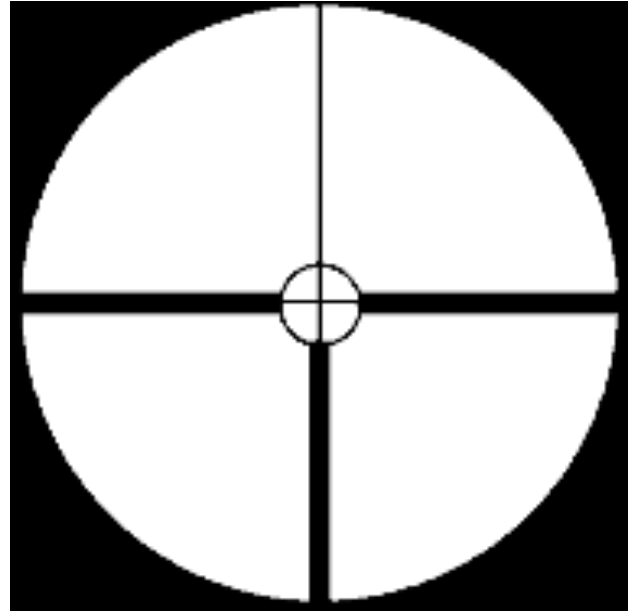

Reticle No. 9

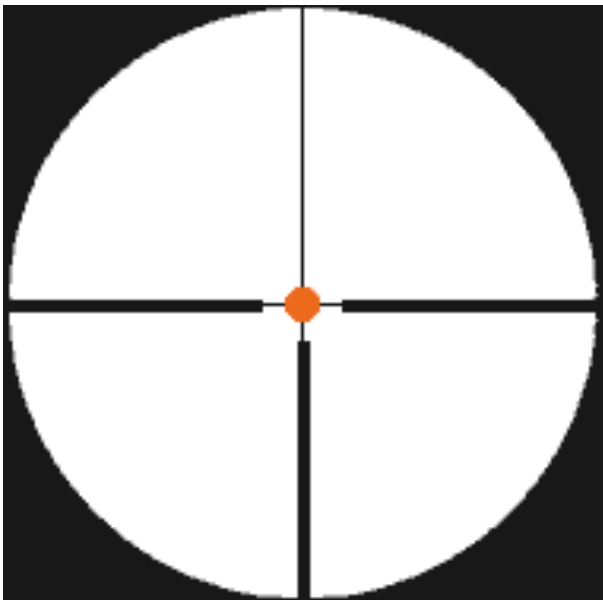

Reticle No. 7 FlashDot

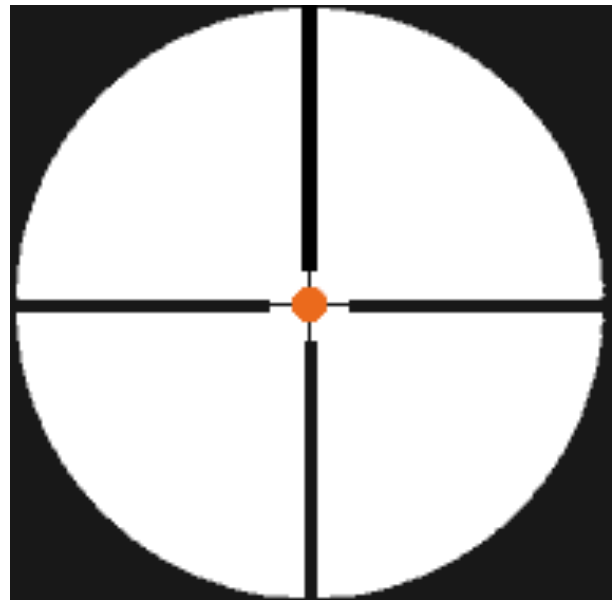

Reticle No. 8 FlashDot

# Schmidt and Bender Reticle Patterns - Illuminated

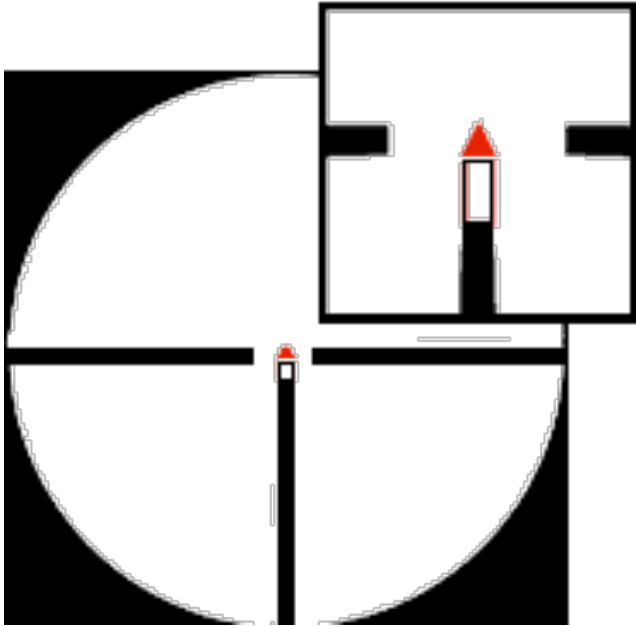

Reticle No. L1

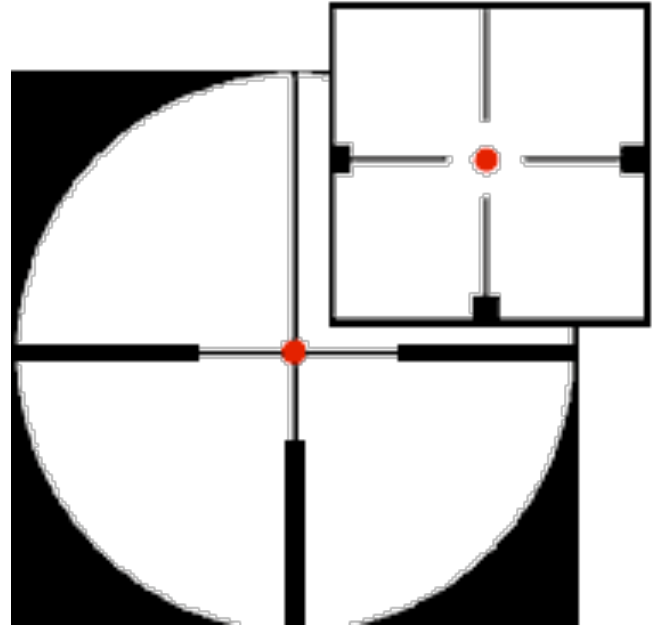

Reticle No. L3

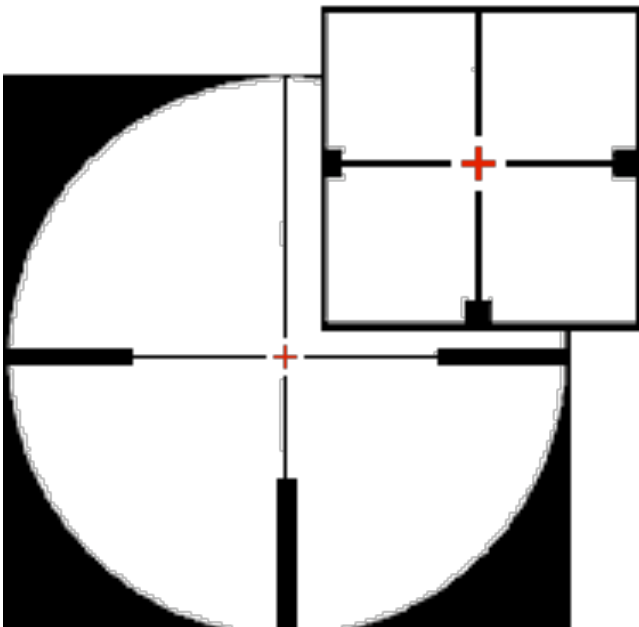

Reticle No. L7

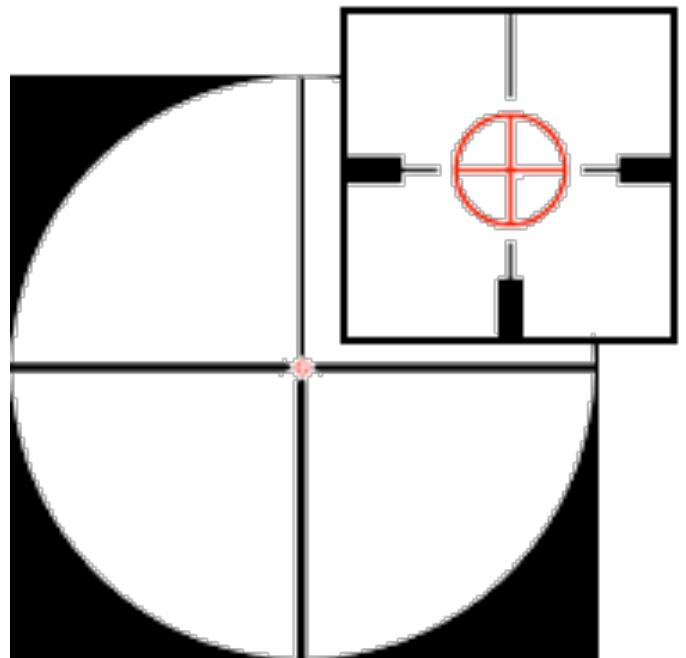

Reticle No. L9

# Schmidt and Bender Reticle Patterns – Police Marksman

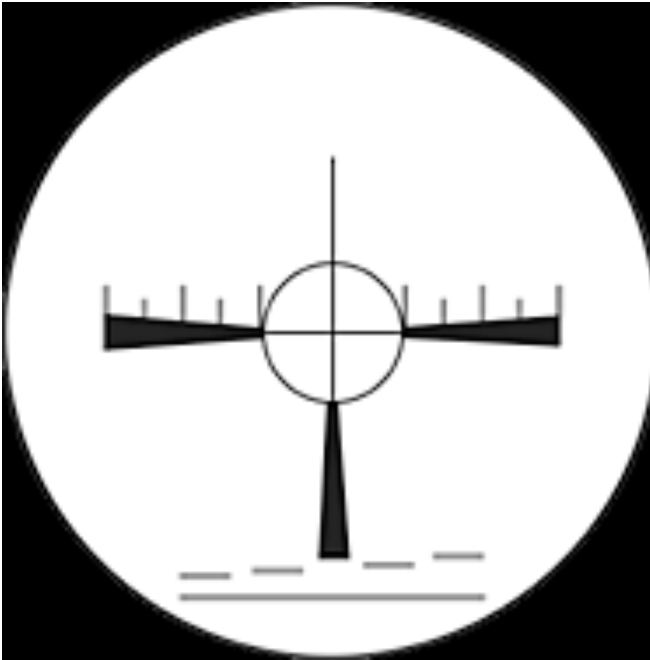

P-1 (Bryant) reticle

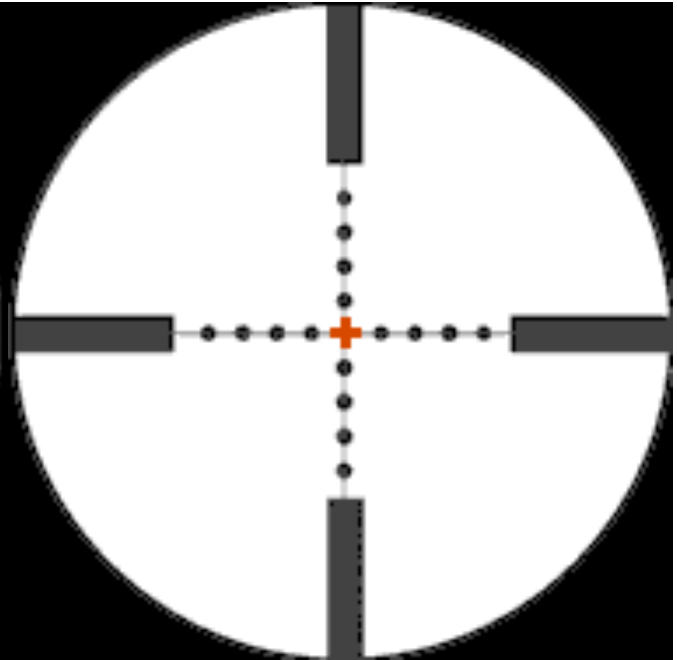

P-3 Mil-dot illuminated

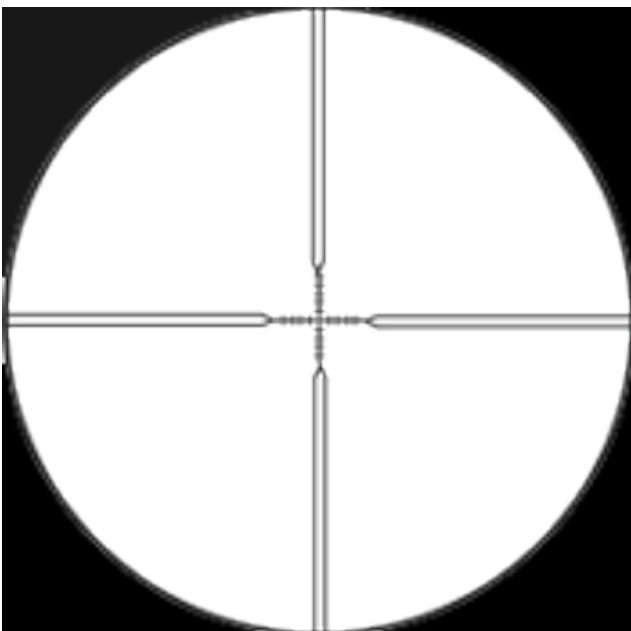

CQB Reticle

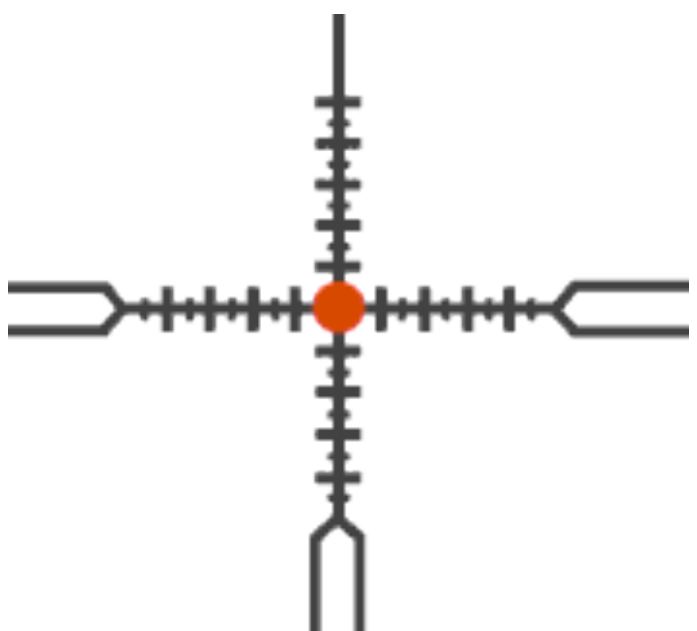

# Schmidt and Bender Reticle Patterns – Police Marksman Illuminated MSR

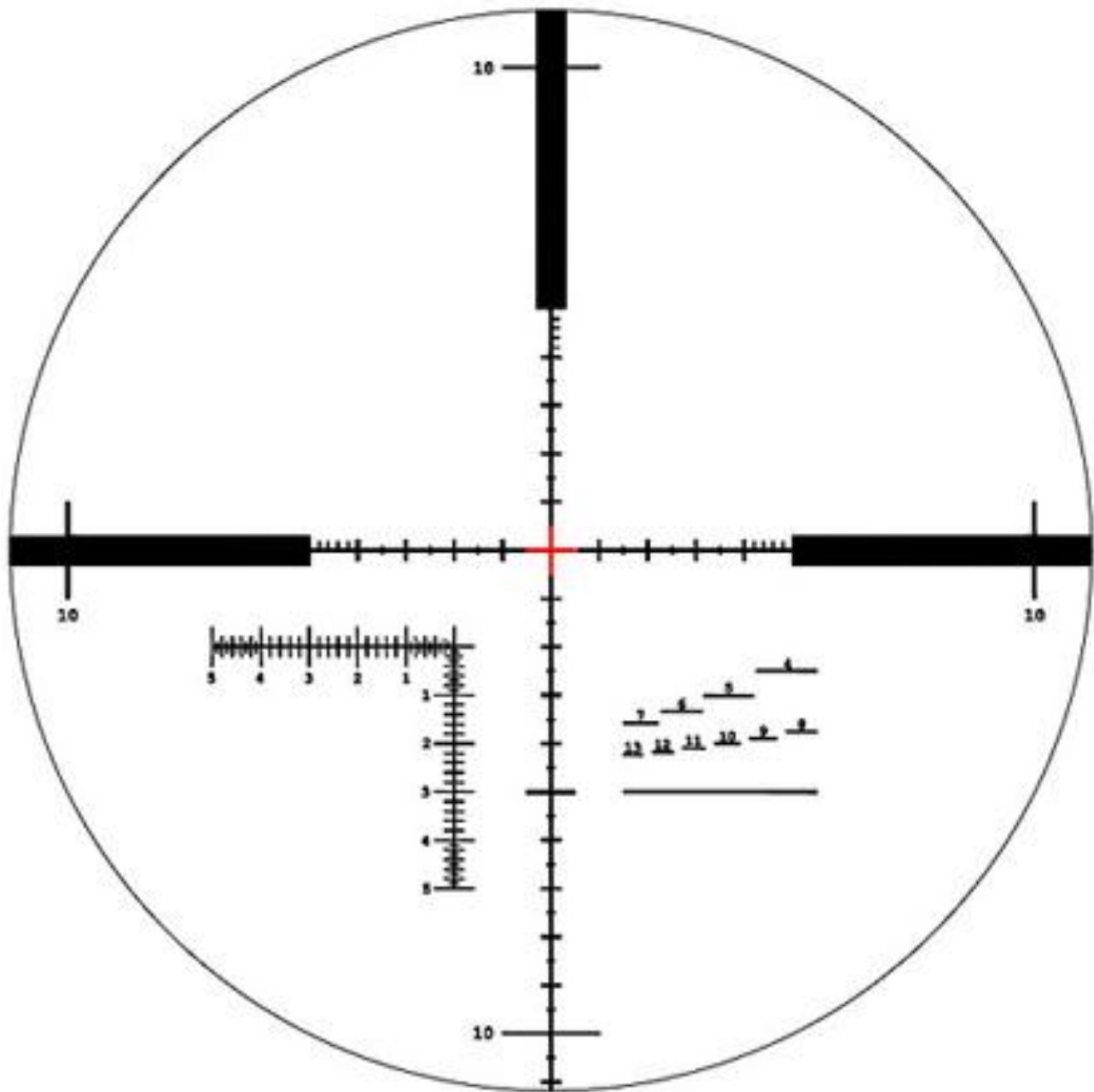



# US OPTICS Reticle Patterns

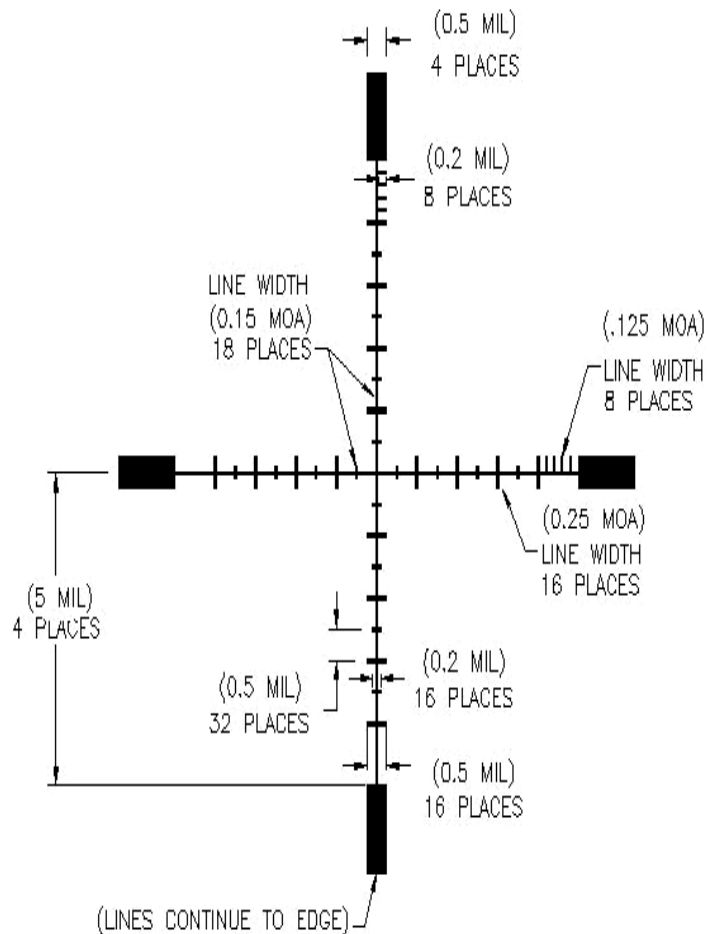
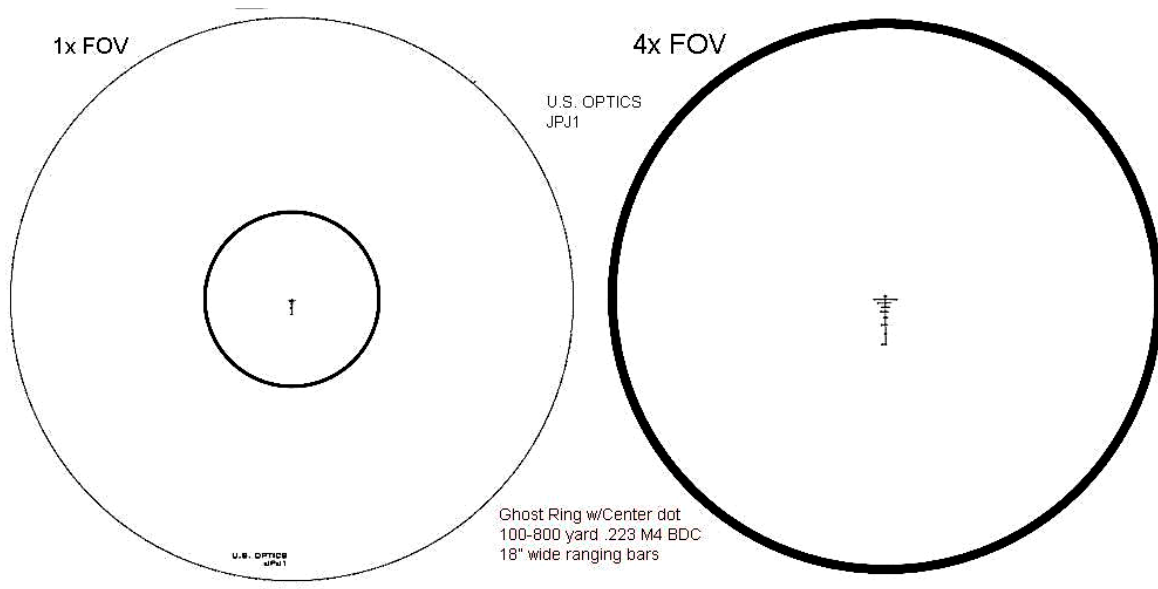

# US OPTICS Reticle Patterns

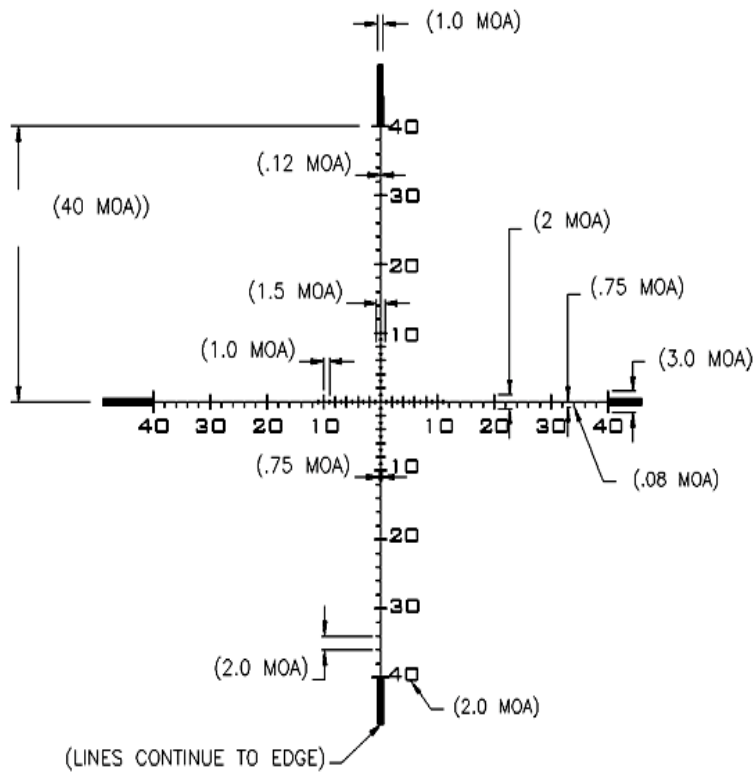
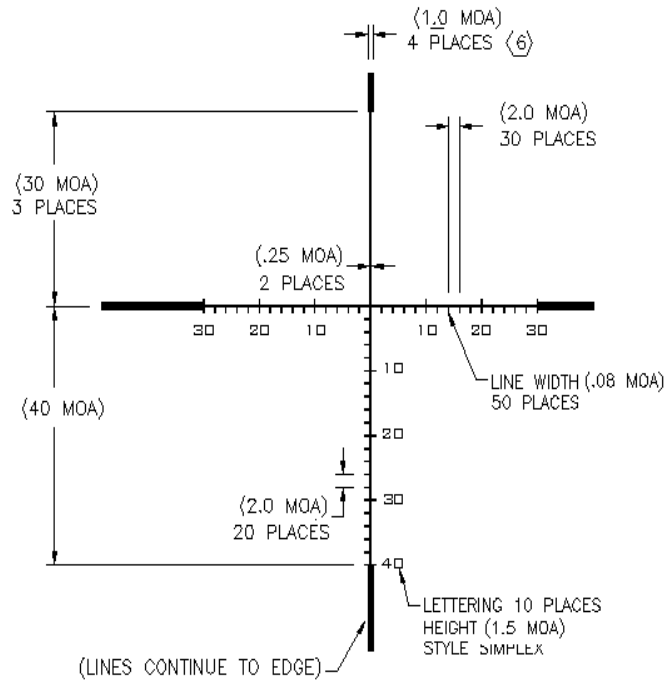

US Optics PCMOA Reticle

# US OPTICS Reticle Patterns

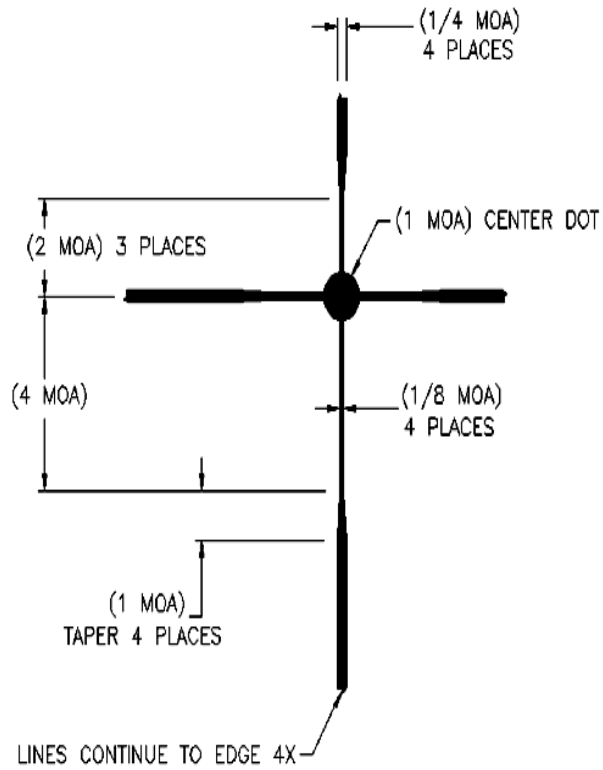
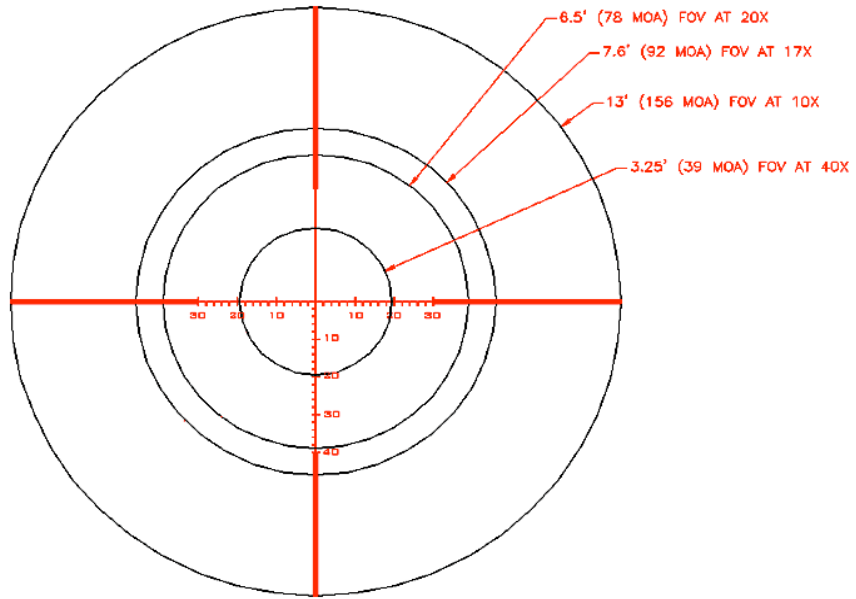

# US OPTICS Reticle Patterns

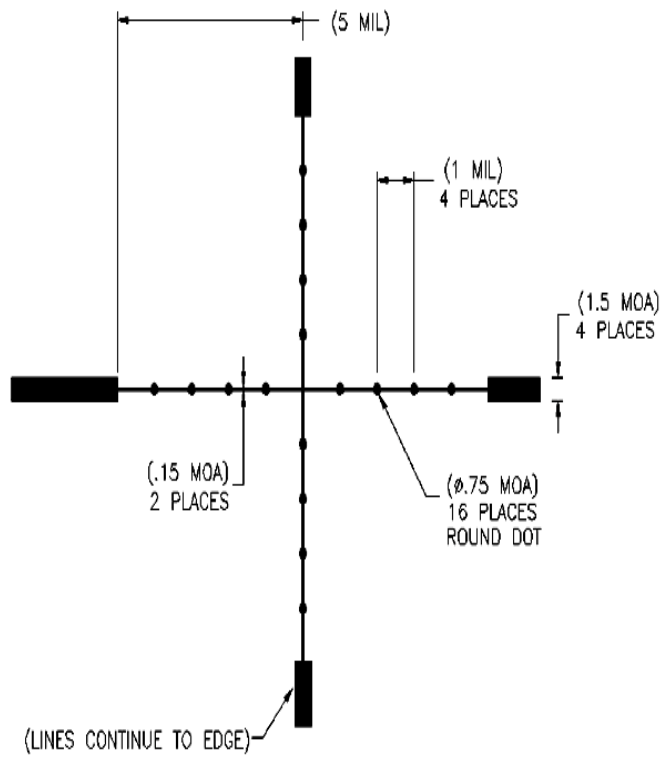
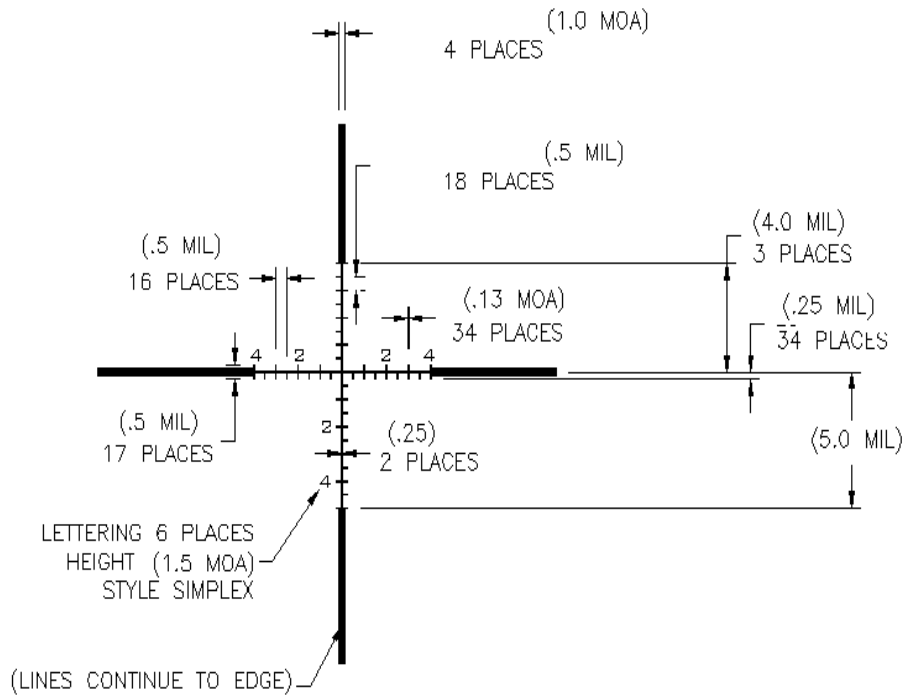

# US OPTICS Reticle Patterns

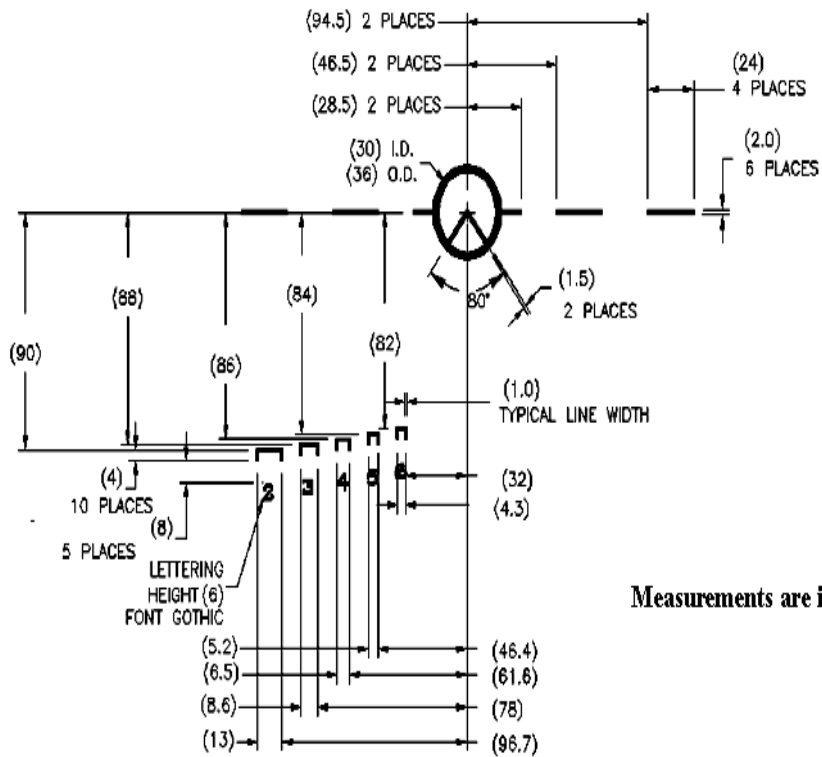
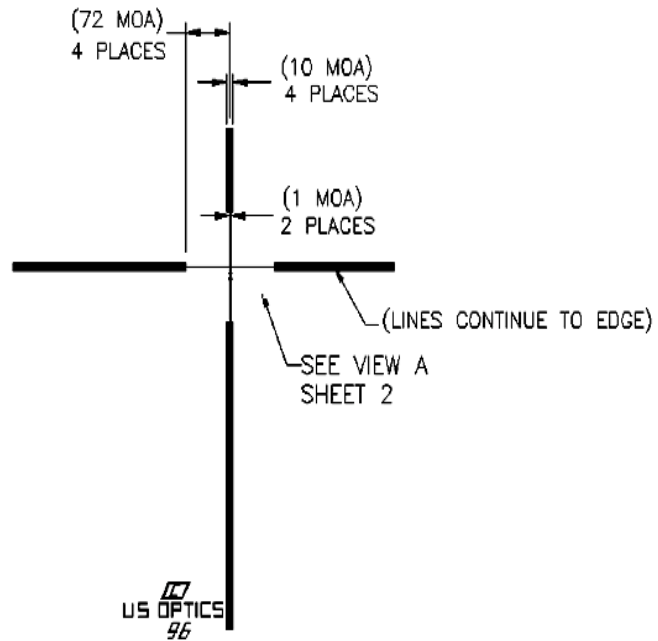

Measurements are in MOA (xx)

# US OPTICS Reticle Patterns

## GAP Mil-Scale

GAP Mil-Scale

Available for 17x and 22x

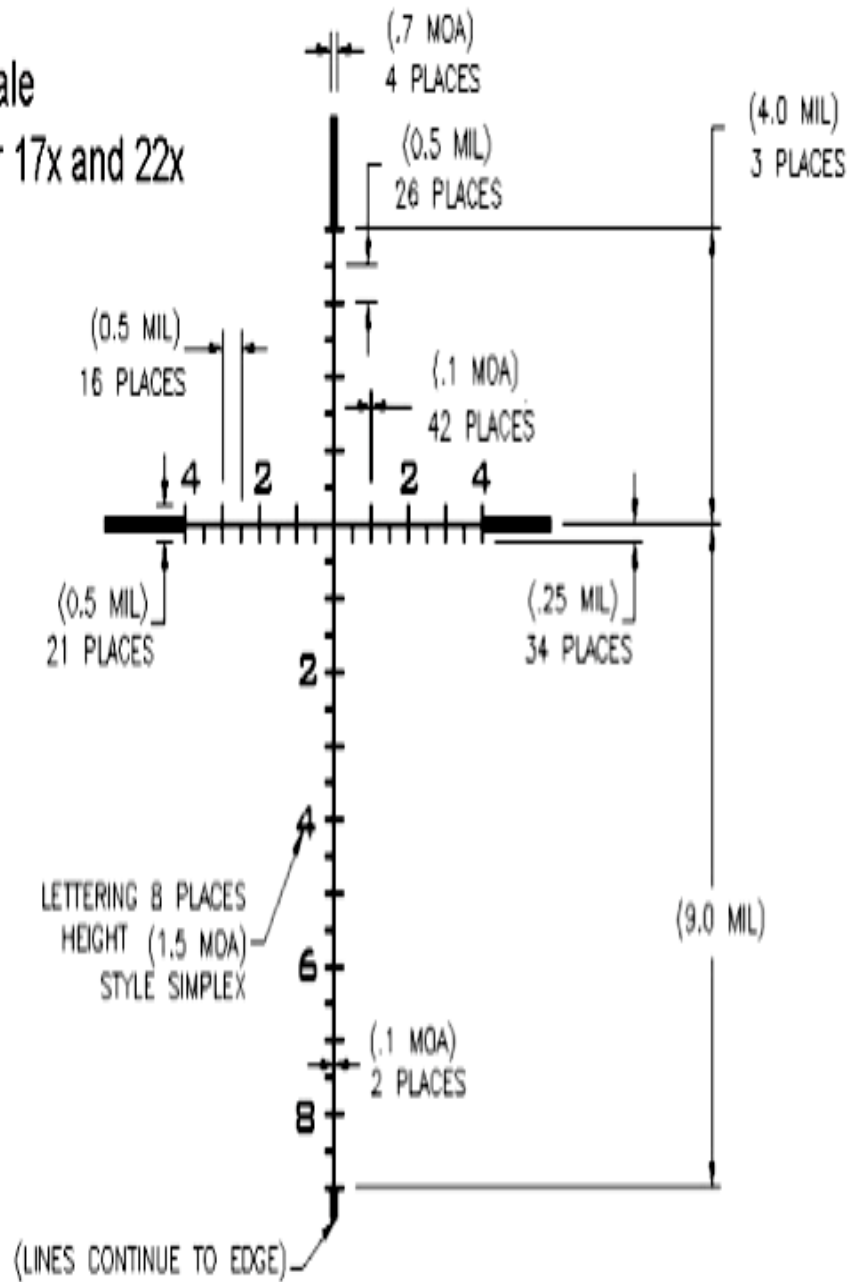

# US OPTICS Reticle Patterns RWF

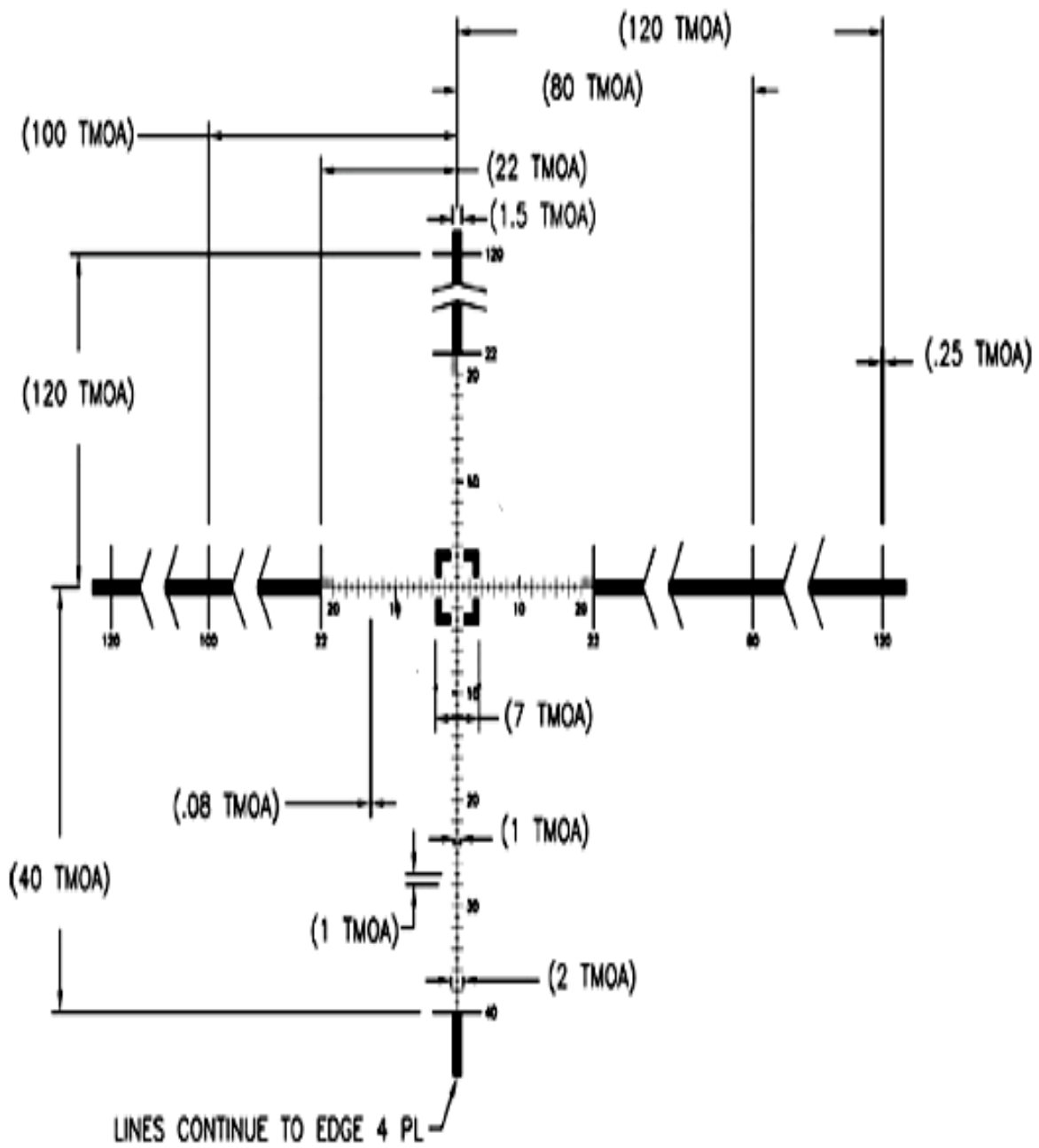

# US OPTICS Reticle Patterns

## RWF 77

RWF-77 Reticle for US Optics SN3 1.8-10 (NON-LIT)

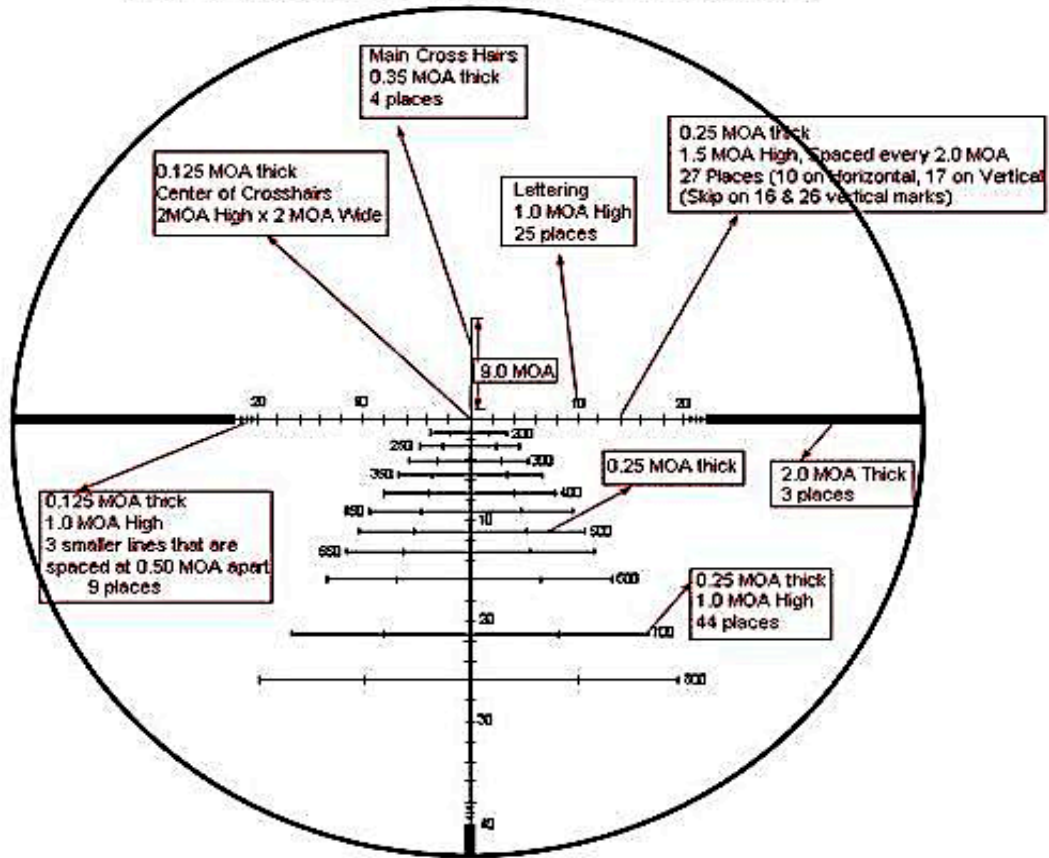

The Bullet Drop Compensator is for 223 caliber using the 77gr SMK going at 2725 FPS for the carbine AR15 rifles  
Here are the numbers in Real MOA for elevation and windage hold overs:

Distance	Elevation	10 MPH Wind	20 MPH Wind	Total length of hold over lines
200 Yards	1.50 MOA	1.75 MOA	3.50 MOA	7.0 MOA
250	2.70	2.25	4.50	9.0
300	4.10	2.75	5.75	11.50
350	5.70	3.50	6.75	13.50
400	7.50	4.00	8.00	16.0
450	9.30	4.50	9.25	18.50
500	11.40	5.25	10.50	21.00
550	13.60	6.00	11.75	22.50
600	16.00	6.75	13.25	26.50
700	21.50	8.25	16.50	33.00
800	28.00	10.00	19.75	39.50



# US OPTICS Reticle Patterns Canadian Mil-Scale

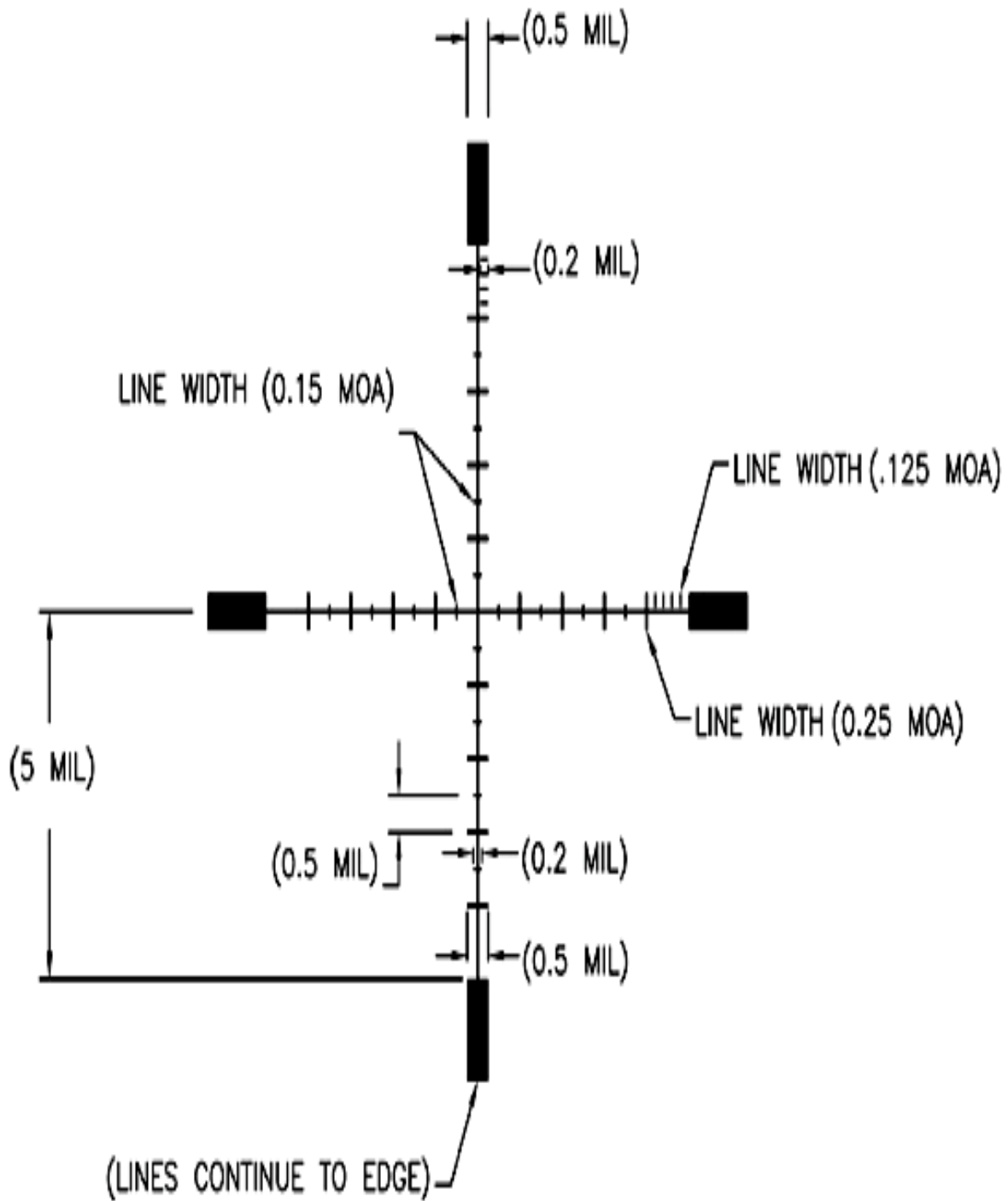

# US OPTICS Reticle Patterns MPR

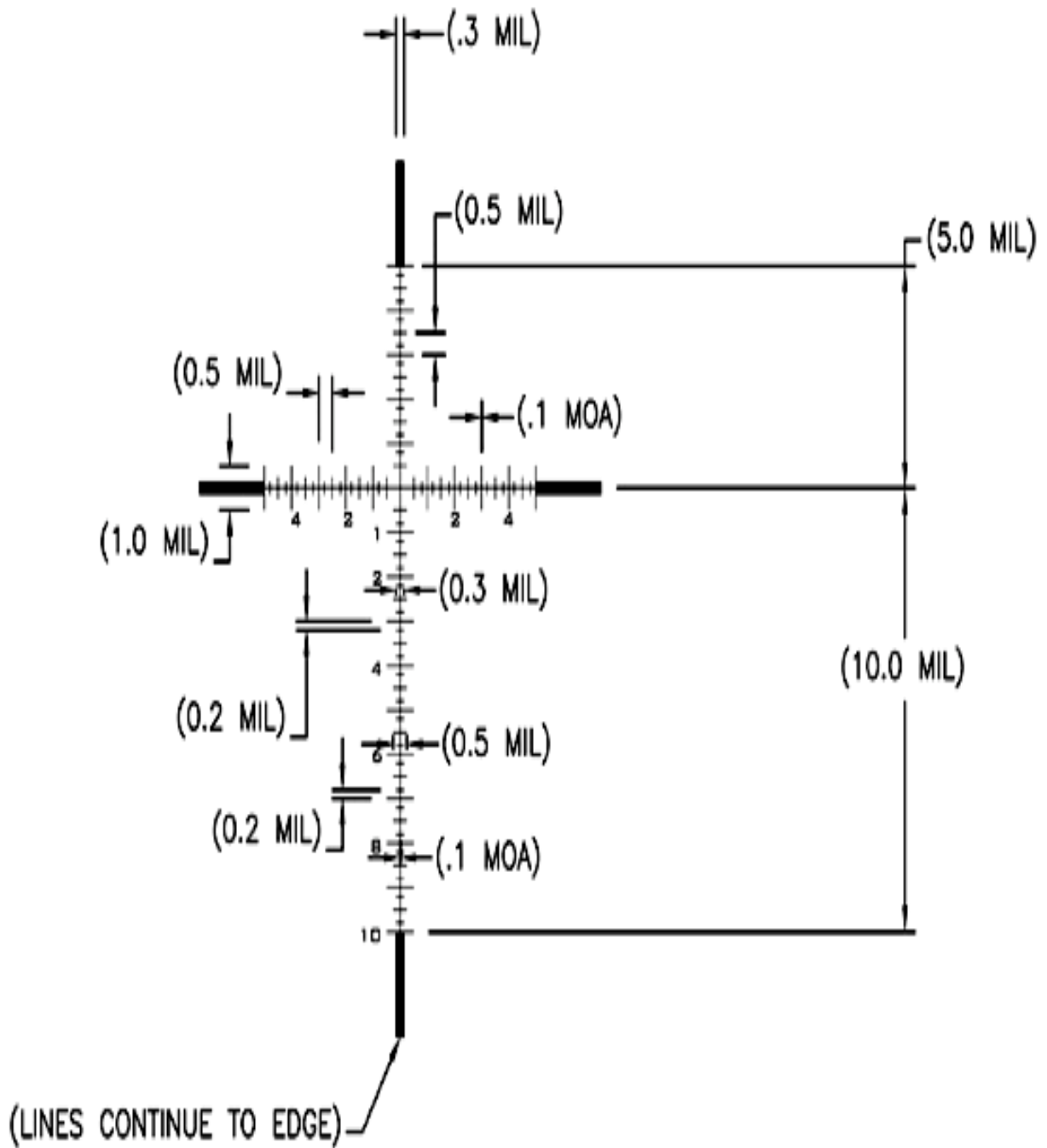

# US OPTICS Reticule Patterns

## JNG Mil & JNG MOA

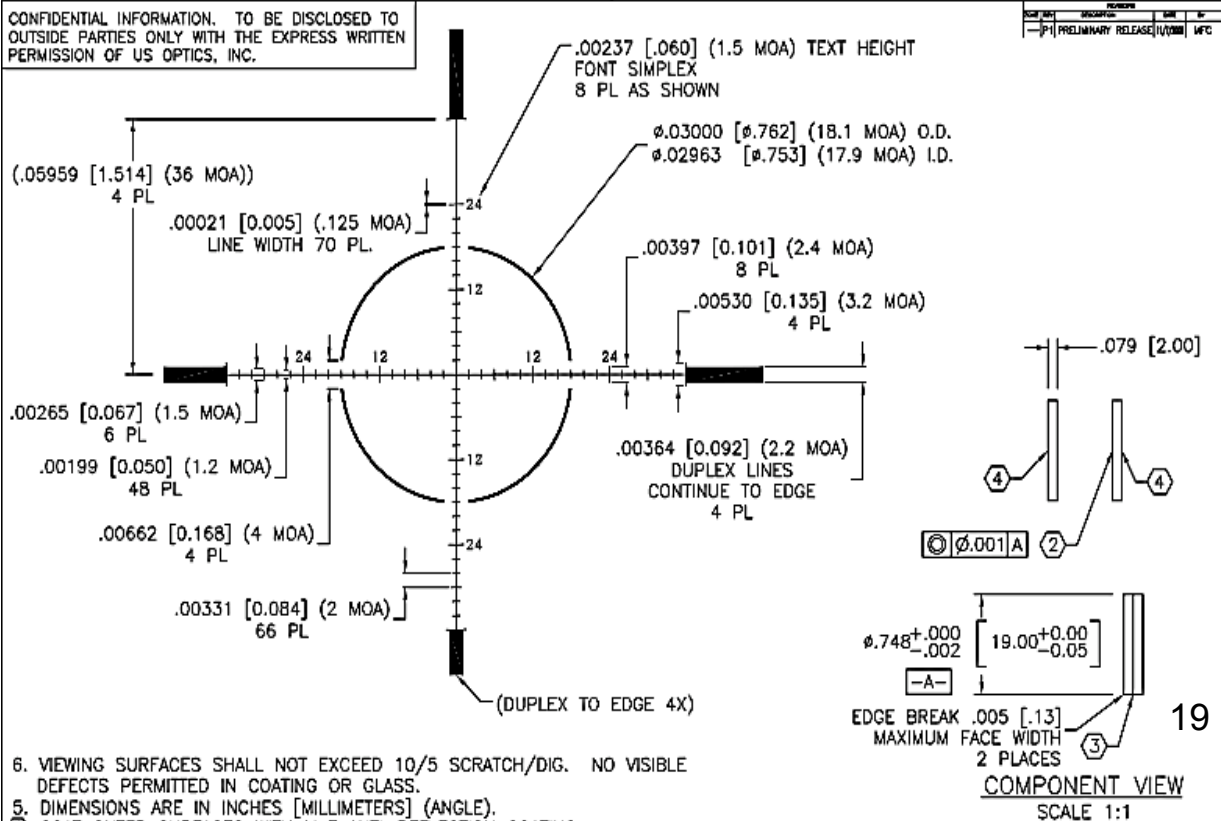
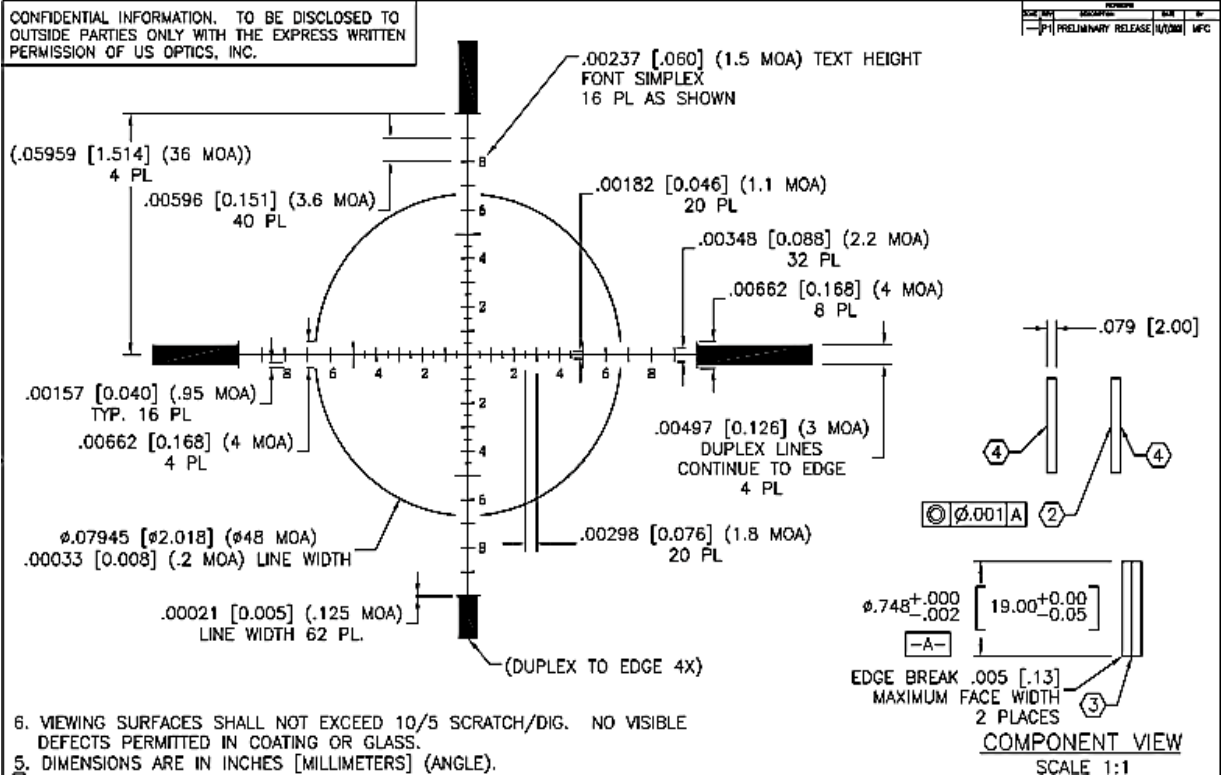

# US OPTICS Reticle Patterns

## Canadian 17x

CONFIDENTIAL INFORMATION. TO BE DISCLOSED TO OUTSIDE PARTIES ONLY WITH THE EXPRESS WRITTEN PERMISSION OF US OPTICS, INC.

REVISION			
NO.	DESCRIPTION	DATE	BY
1	PRELIMINARY SKETCH (1700M)		WFC

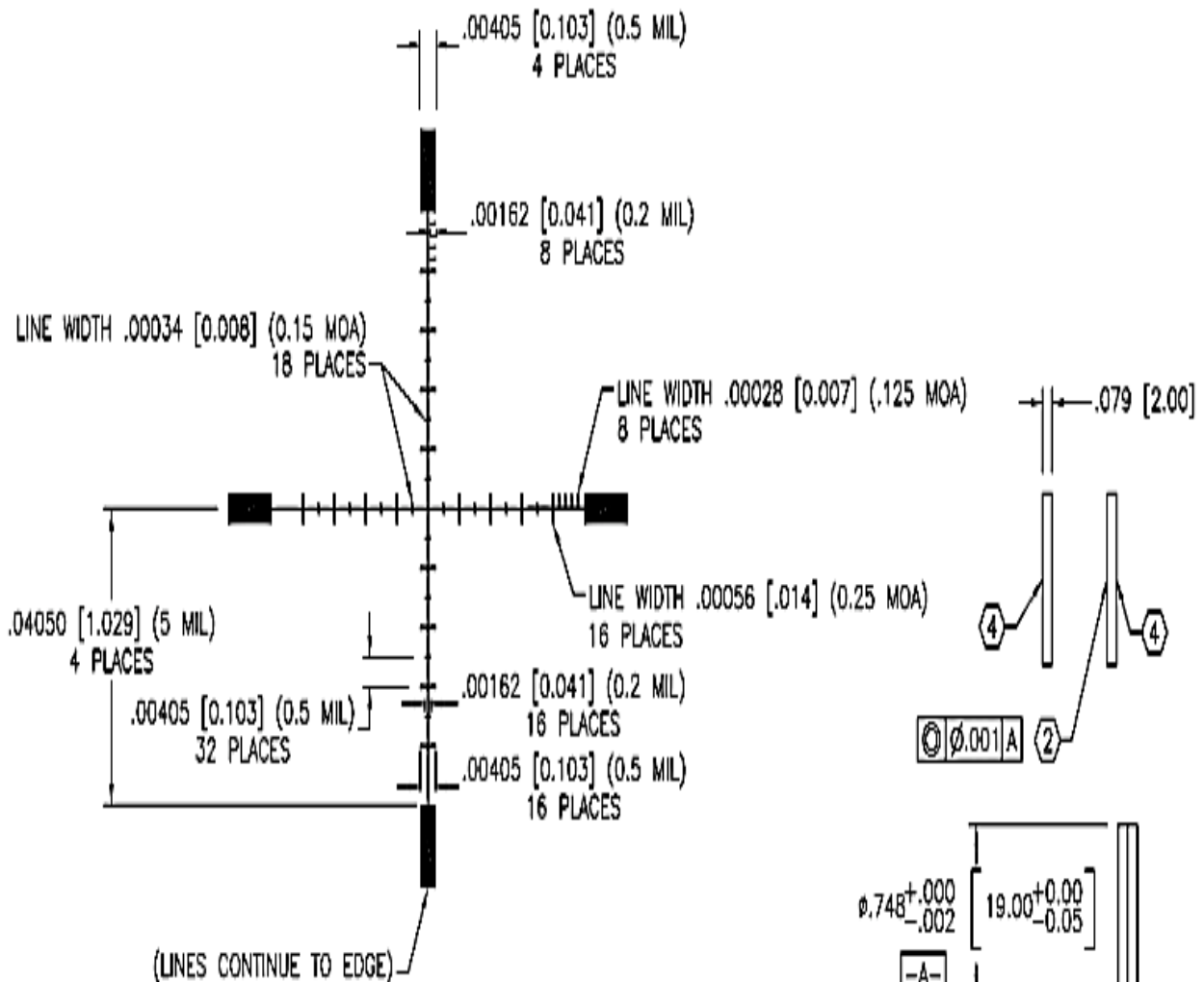

EDGE BREAK  $.005 [0.13]$   
 MAXIMUM FACE WIDTH  
 2 PLACES

COMPONENT VIEW

SCALE 1:1 20

6. SURFACE SHALL NOT EXCEED 10/5 SCRATCH/DIG. NO VISIBLE DEFECTS PERMITTED IN COATING OR GLASS.

5. DIMENSIONS ARE IN INCHES [MILLIMETERS] (ANGLE).

# US OPTICS Reticle Patterns

## RDP Mil 17

CONFIDENTIAL INFORMATION. TO BE DISCLOSED TO OUTSIDE PARTIES ONLY WITH THE EXPRESS WRITTEN PERMISSION OF US OPTICS, INC.

REVISIONS			
NO.	DATE	DESCRIPTION	BY
1		PRELIMINARY RELEASE (MIL/COM)	MFC

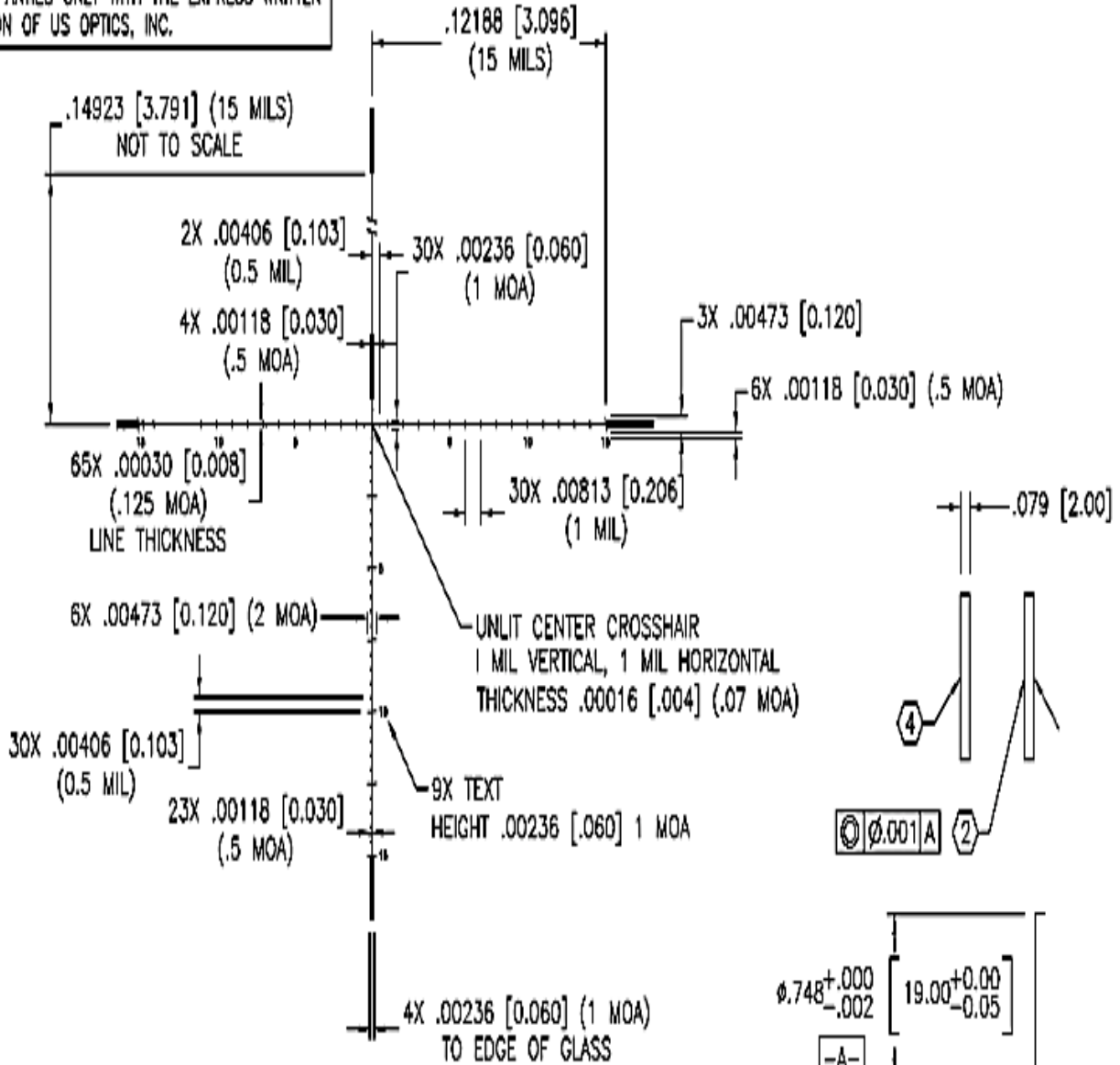

- ANGULAR MEASUREMENTS TRUE MOA ("TMOA").
- SURFACE SHALL NOT EXCEED 10/5 SCRATCH/DIG. NO VISIBLE DEFECTS PERMITTED IN COATING OR GLASS.
- DIMENSIONS ARE IN INCHES [MILLIMETERS] (ANGLE).

COMPONENT VIEW

# US OPTICS Reticle Patterns

## RDP MOA

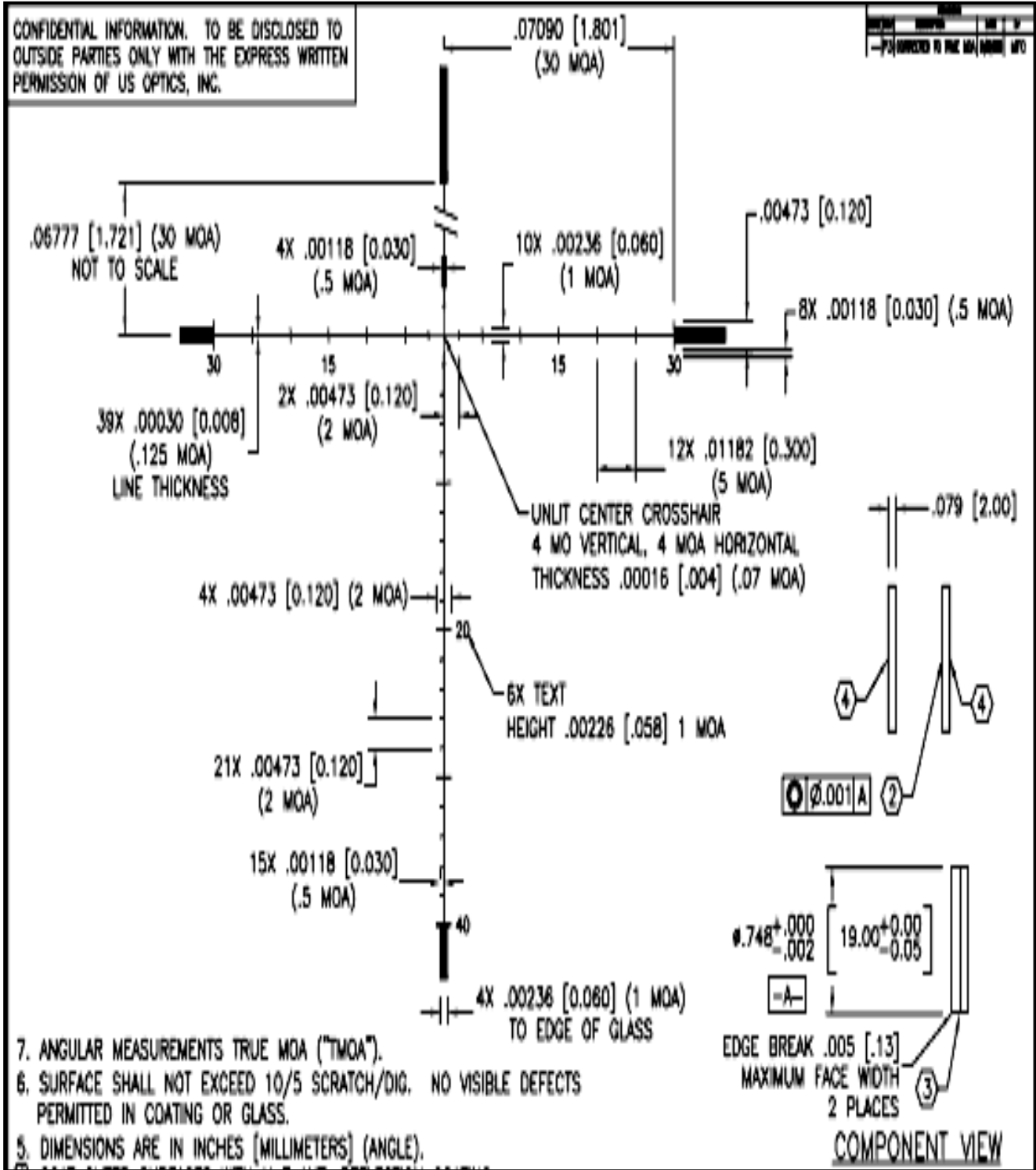

# Horus H59 Improved Sniper Reticle with Illumination

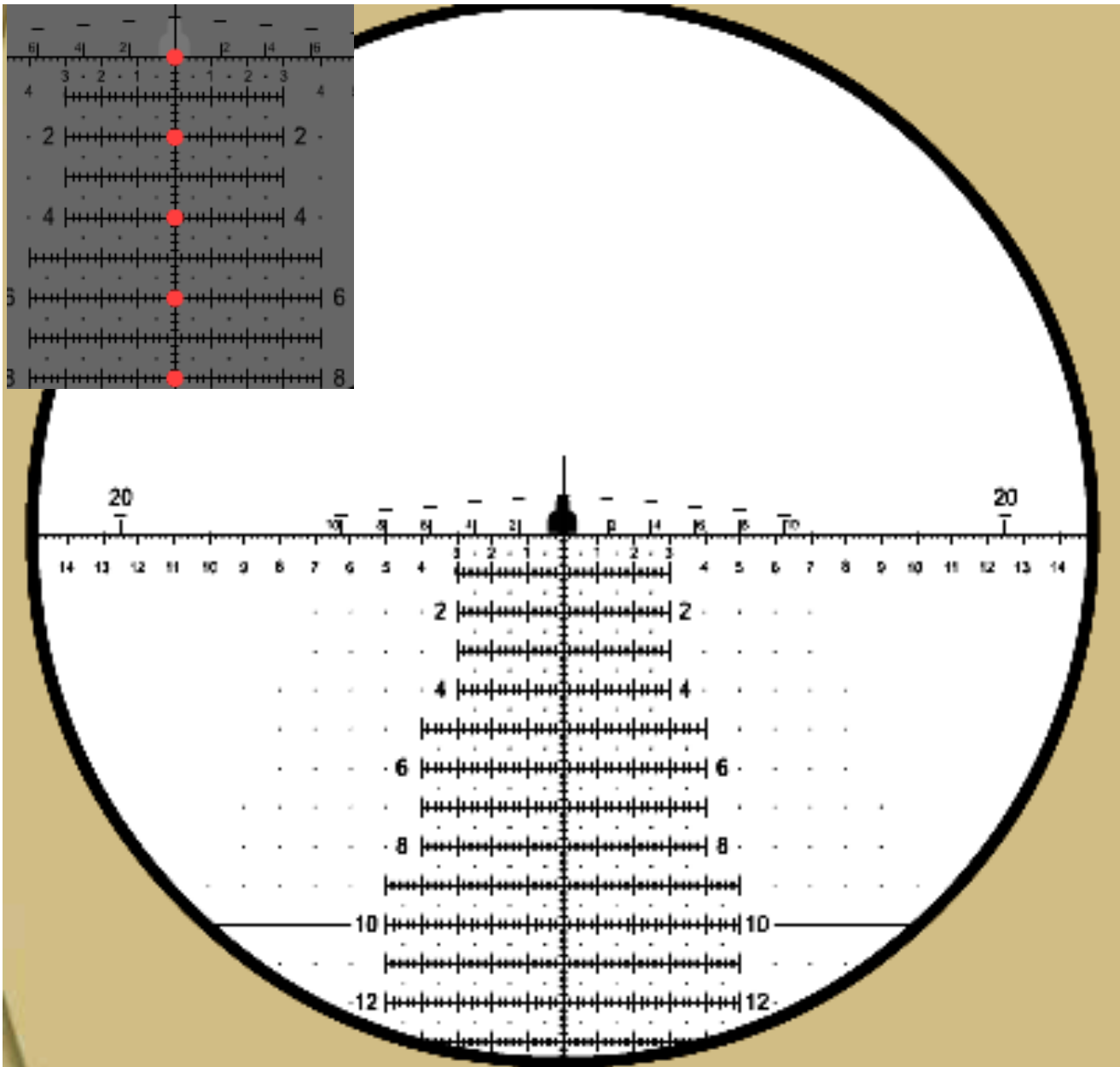

# Horus H59 Dual Plane Improved Sniper Reticle with Illumination

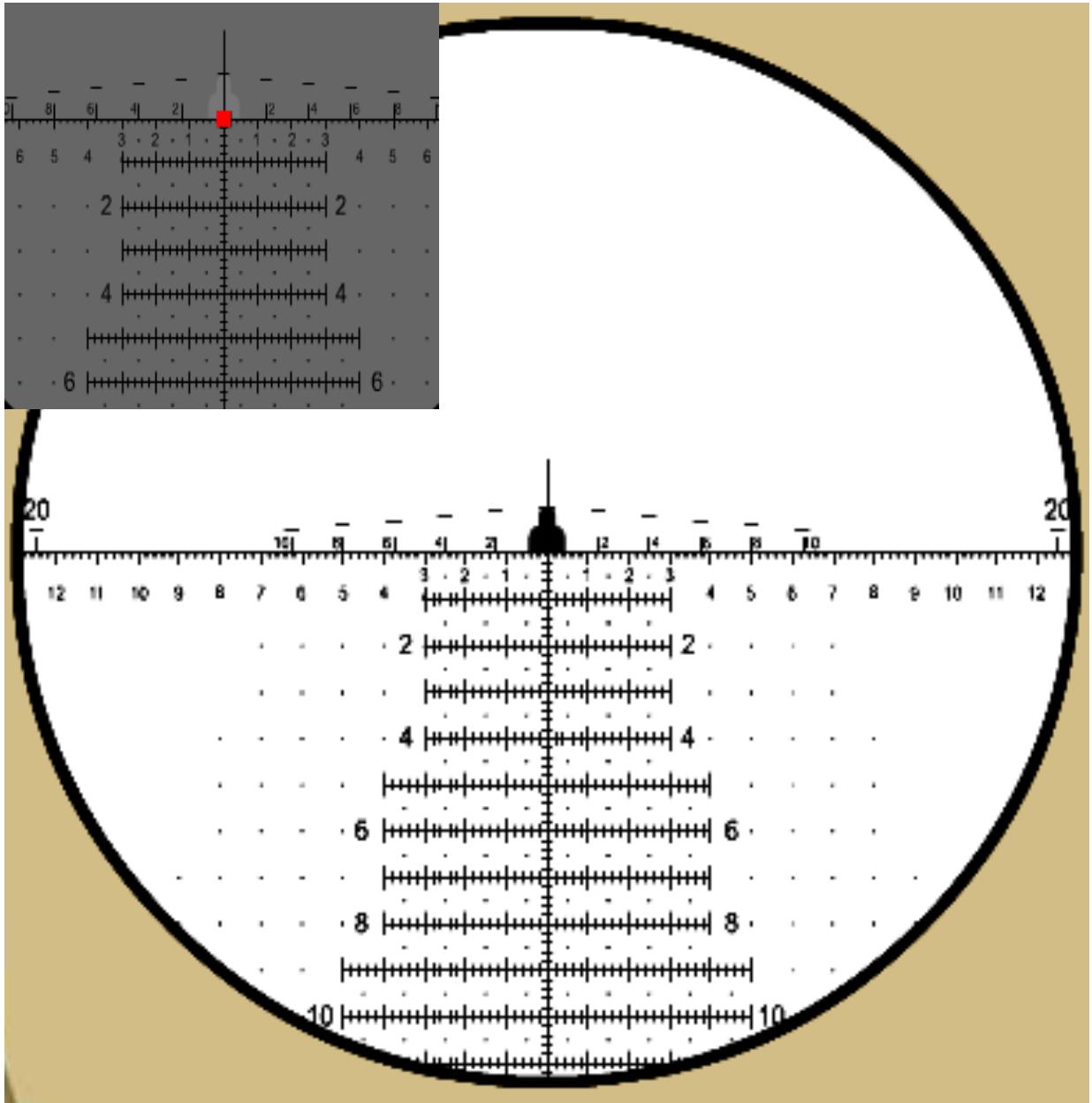



# Horus H50 Close Quarters Reticle with Illumination

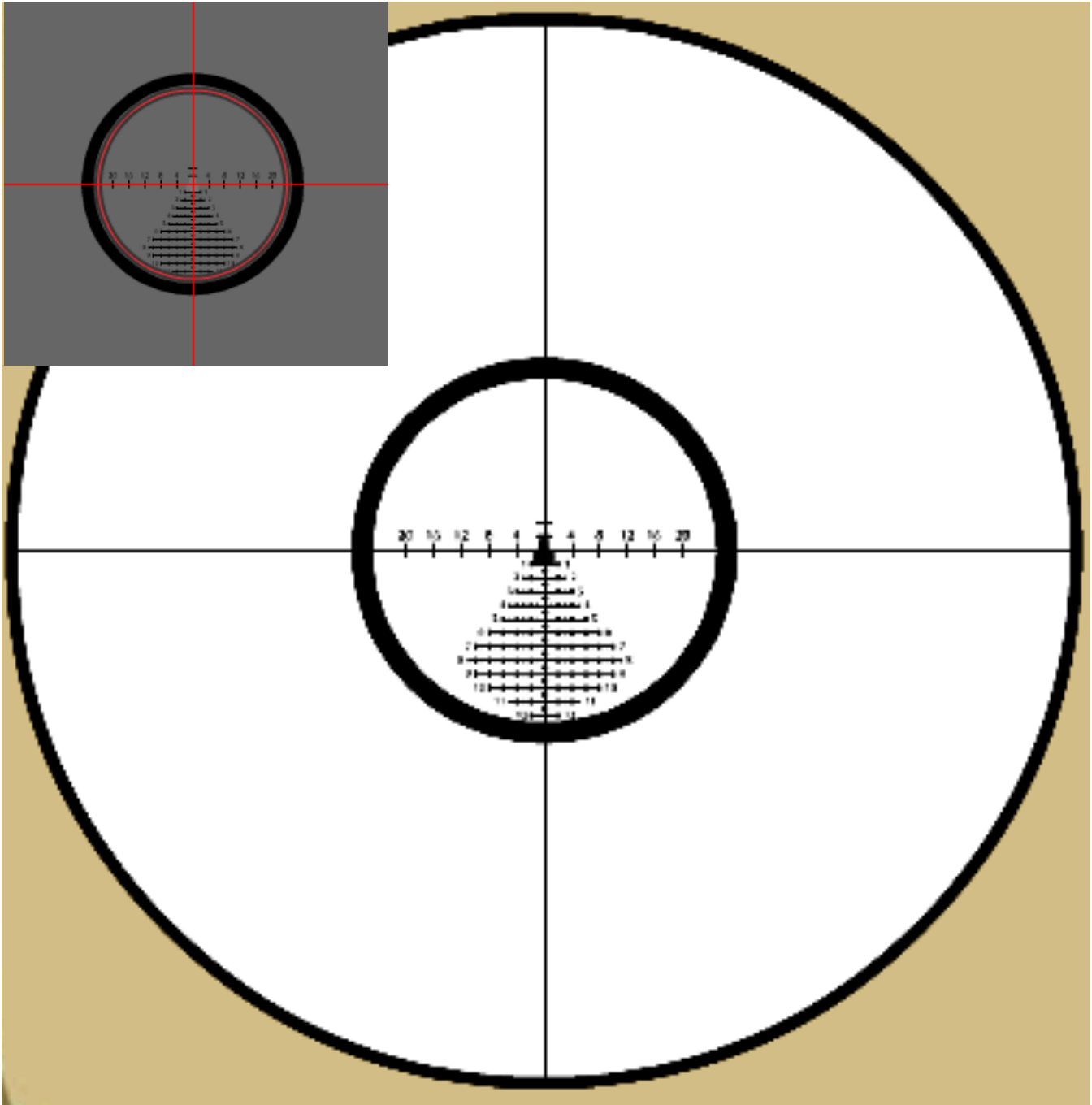

# Horus TReMoR2 Reticle with Illumination

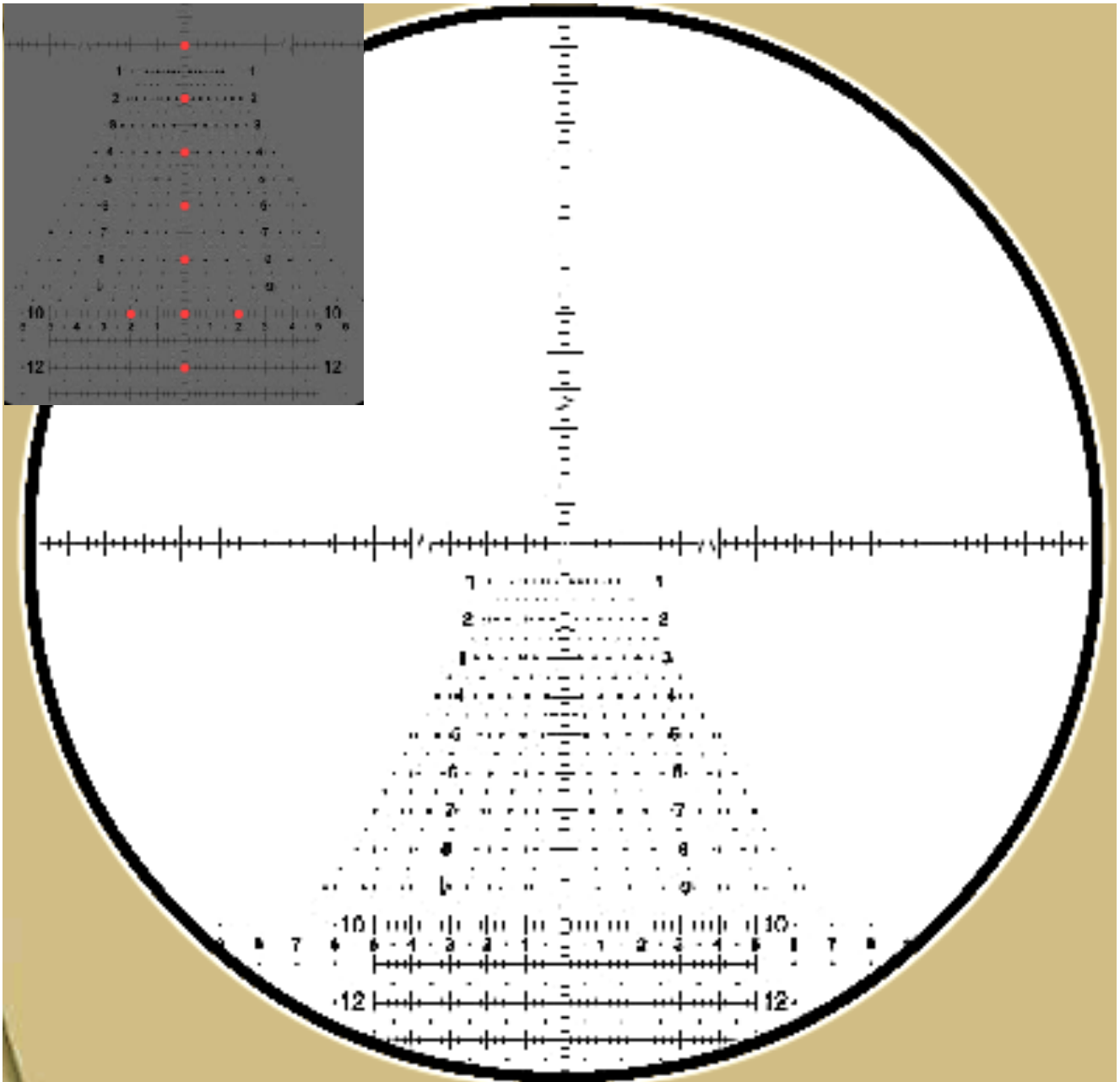

# Horus H425 Hunting Half Grid Reticle

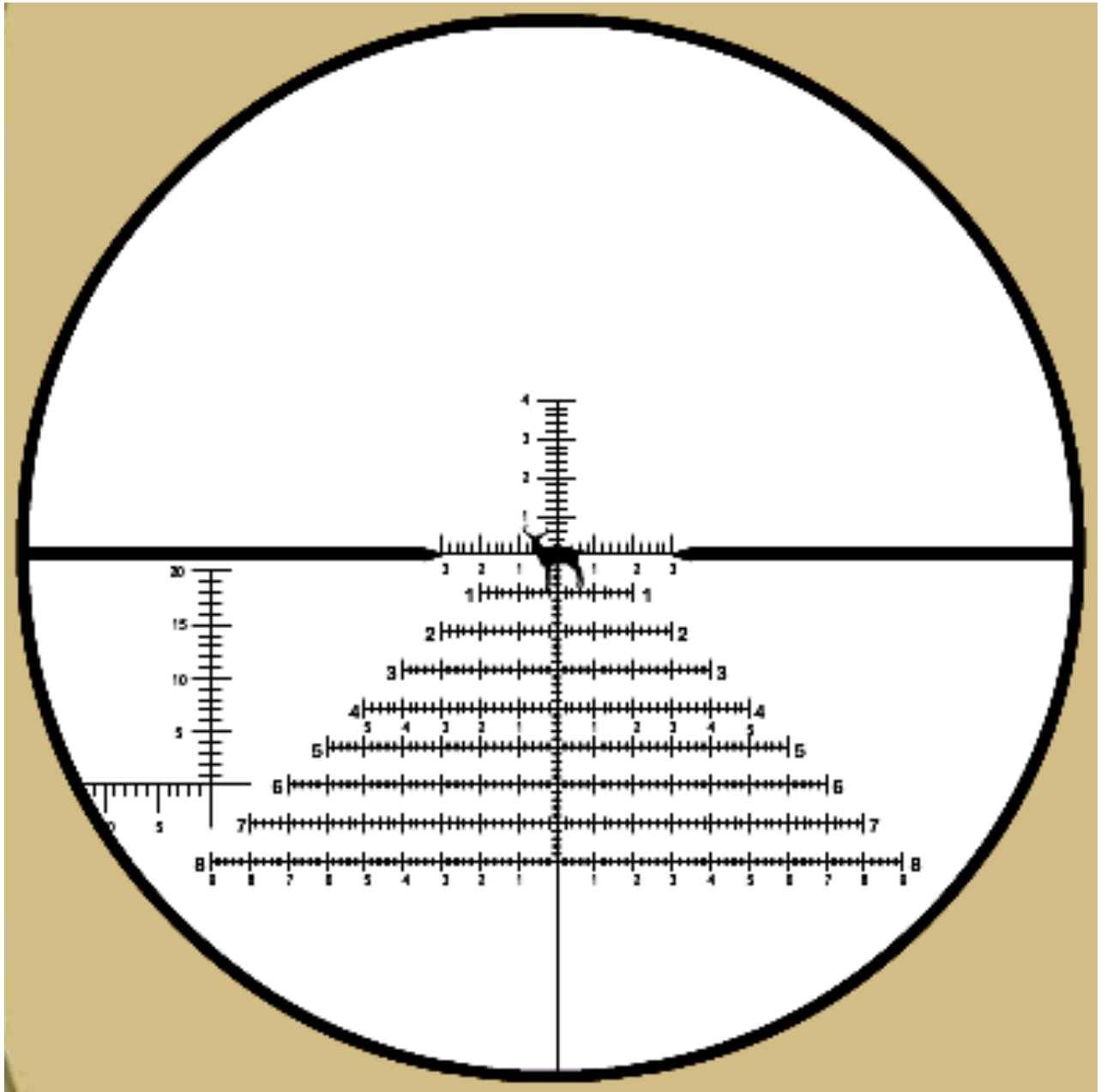

# Horus H32 Observational Measurement Spotting Reticule

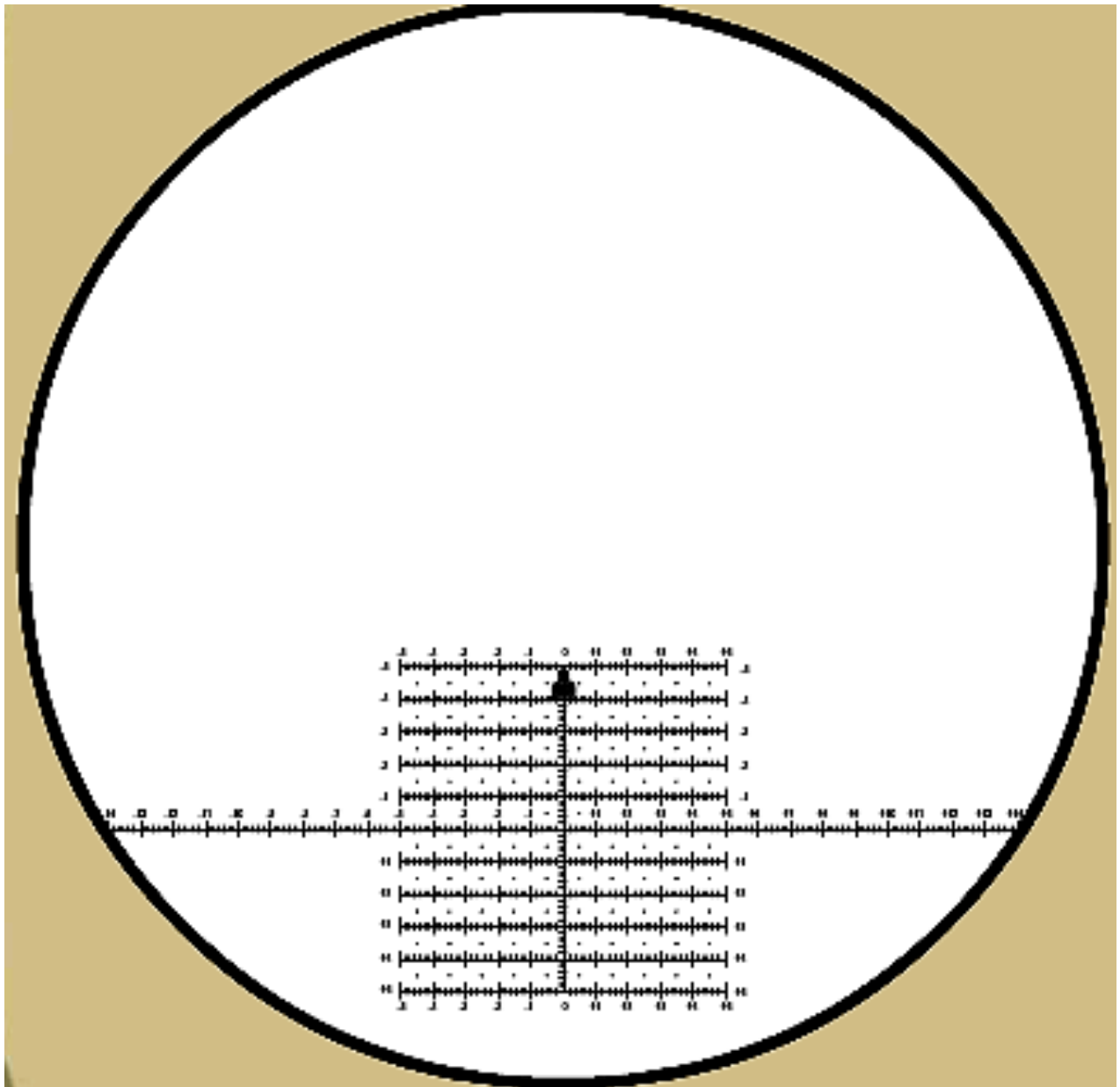

# Horus H36 Observational Range Finder Spotting Reticle

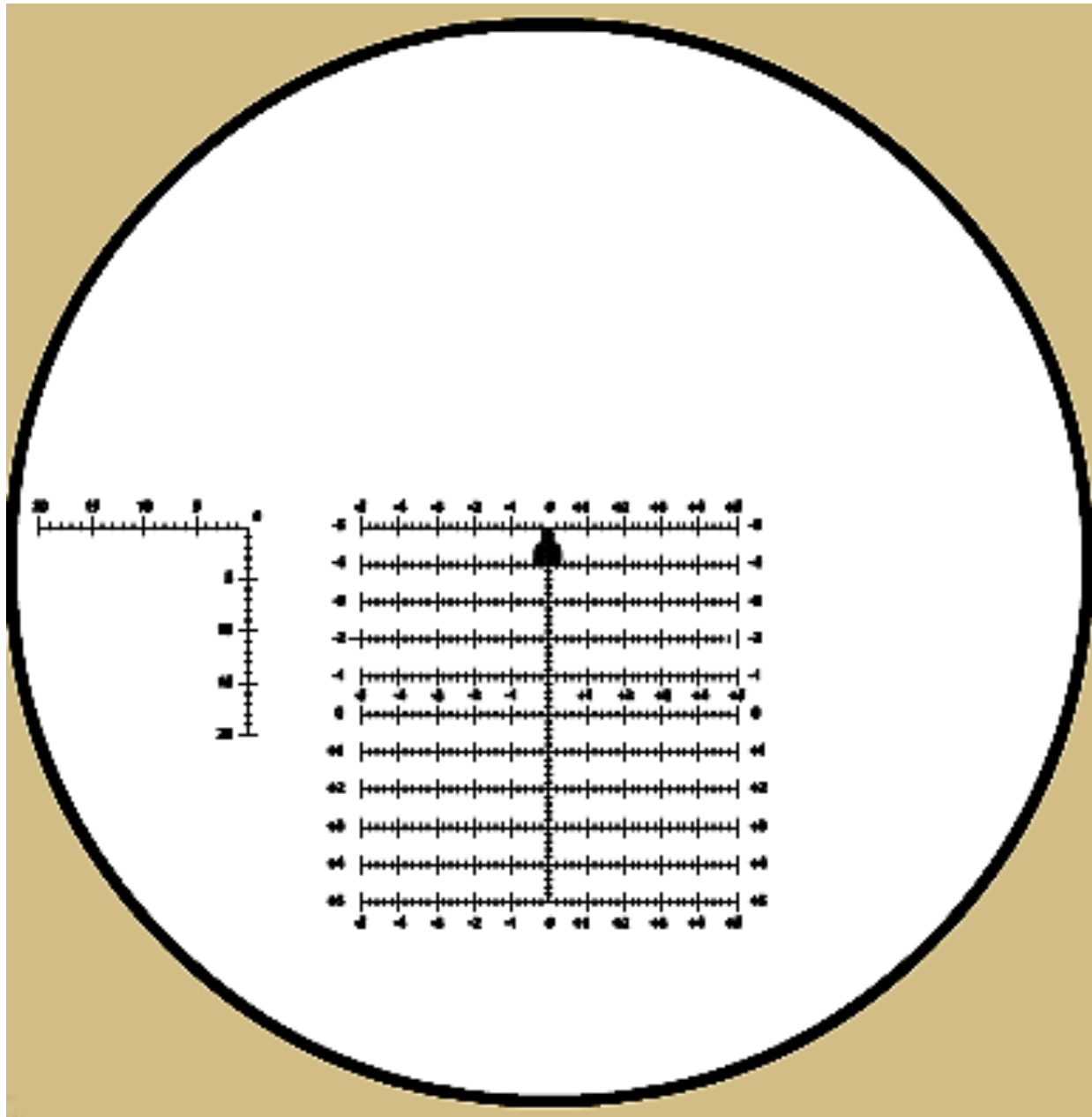

# Horus Vision Reticle Patterns

**H25**

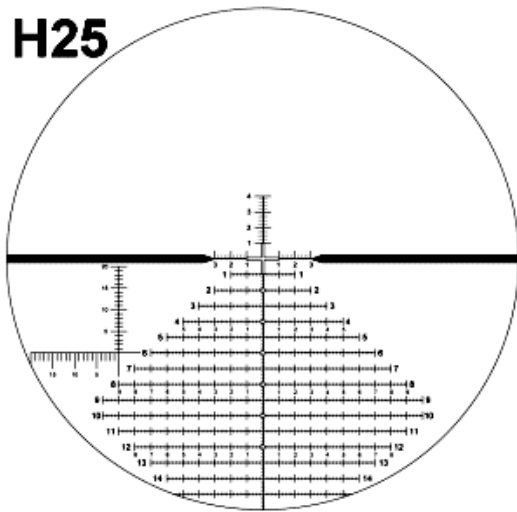

**H31**

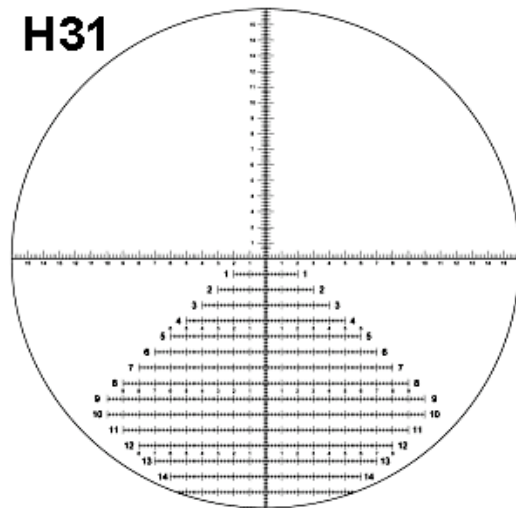

**H39**

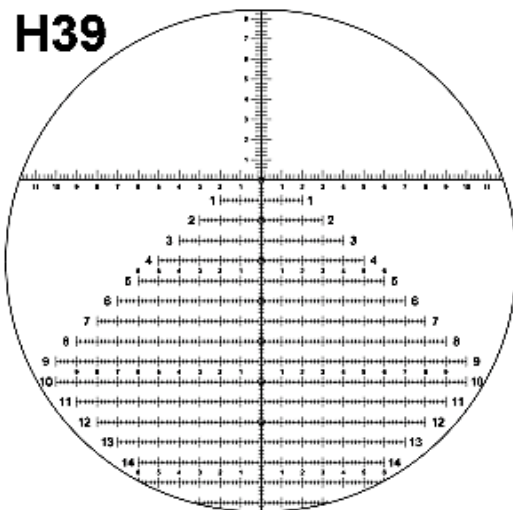

**H45**

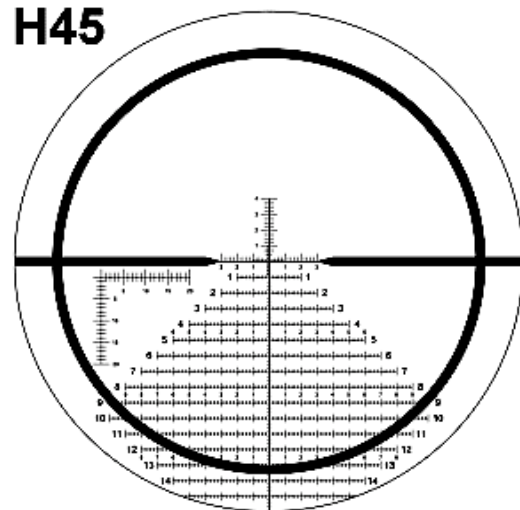

**H48**

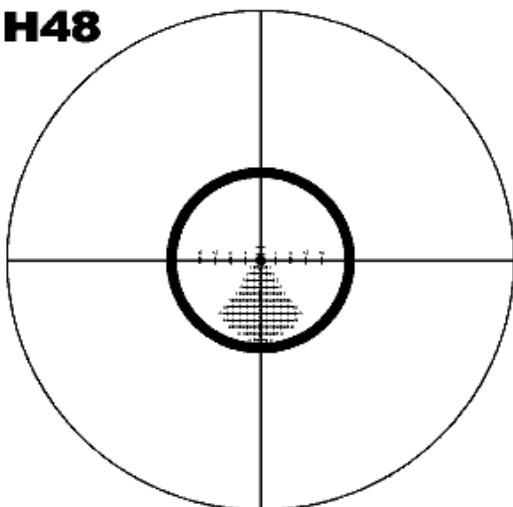

**H70**

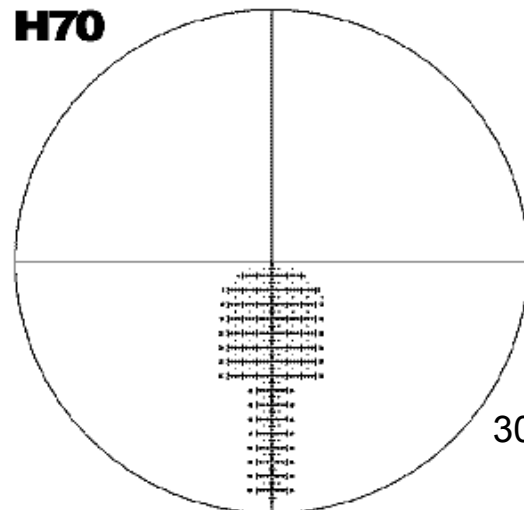

# Horus Vision Reticle Patterns

H2

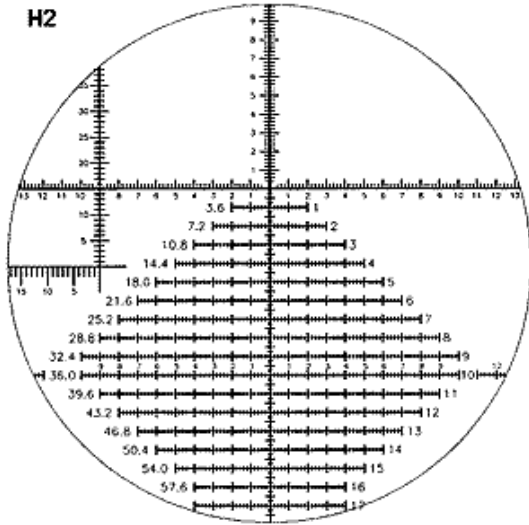

H3

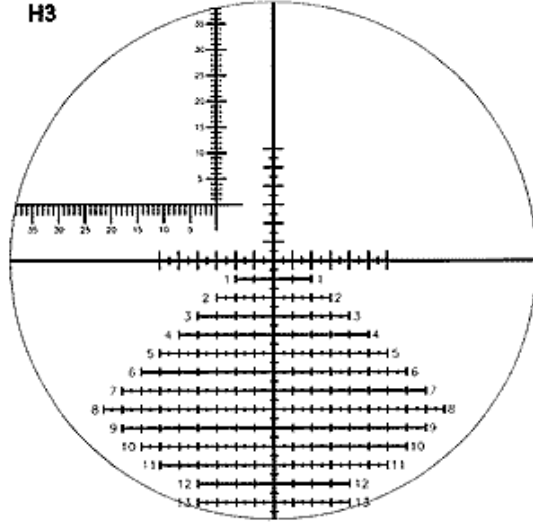

H4

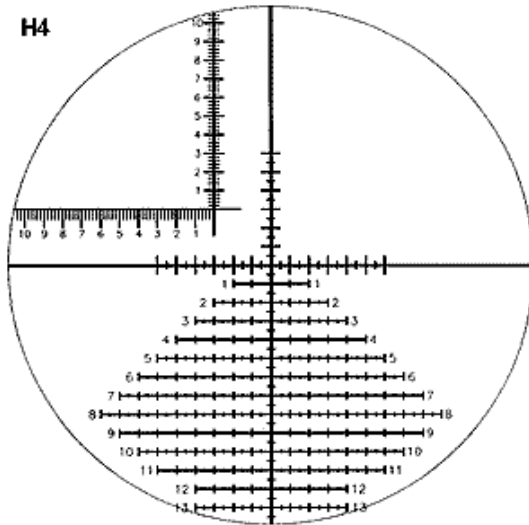

H1

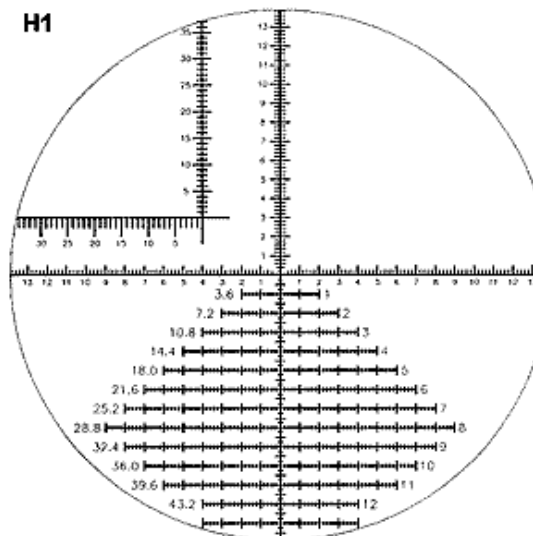

H19

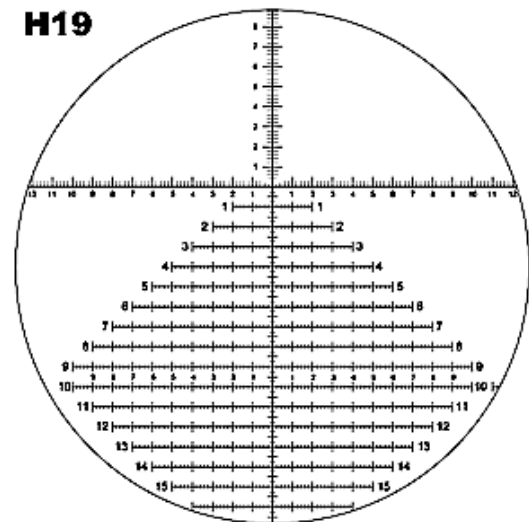

H-21

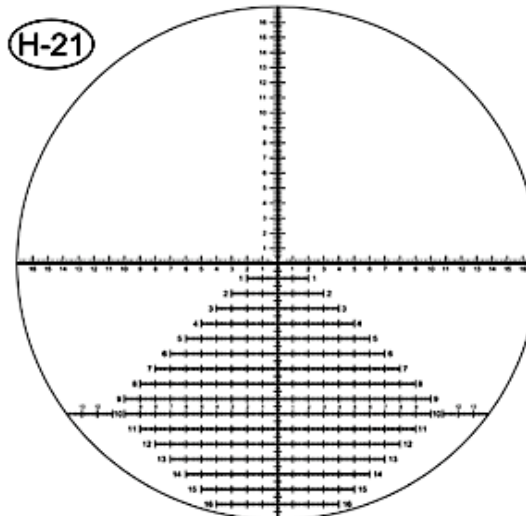

# Horus Vision Reticle Patterns

**H35**

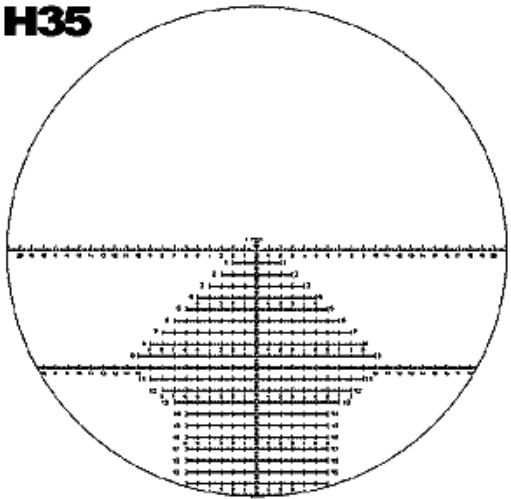

**H5**

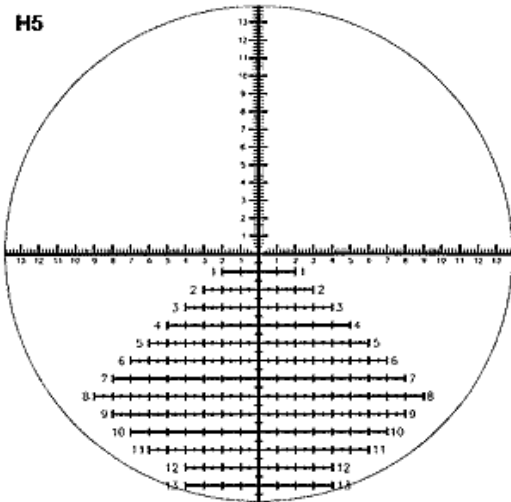

**H12**

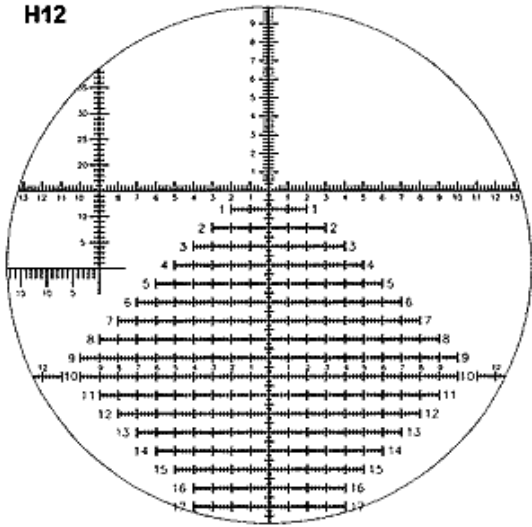

**H37**

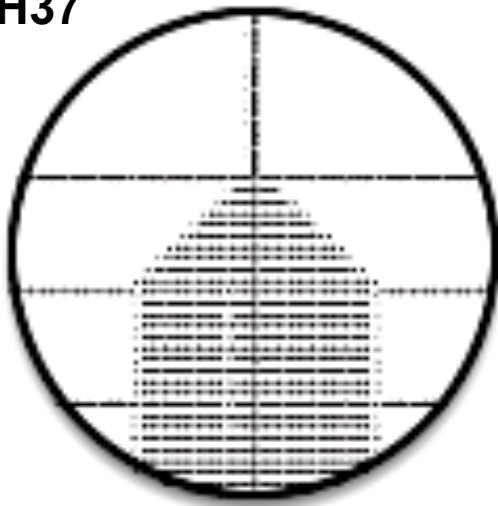

**H27**

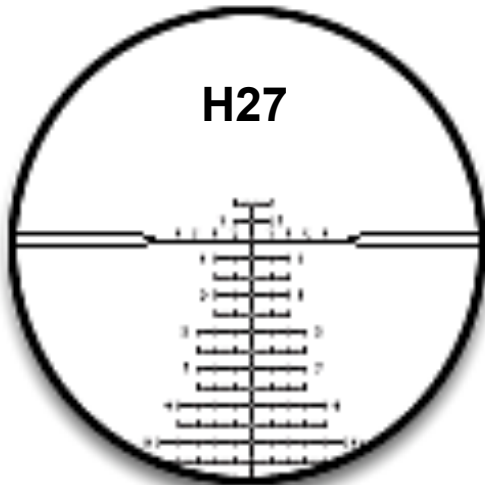



# NightForce Reticle Patterns

## NP-RF1 Field Tactical Long Range

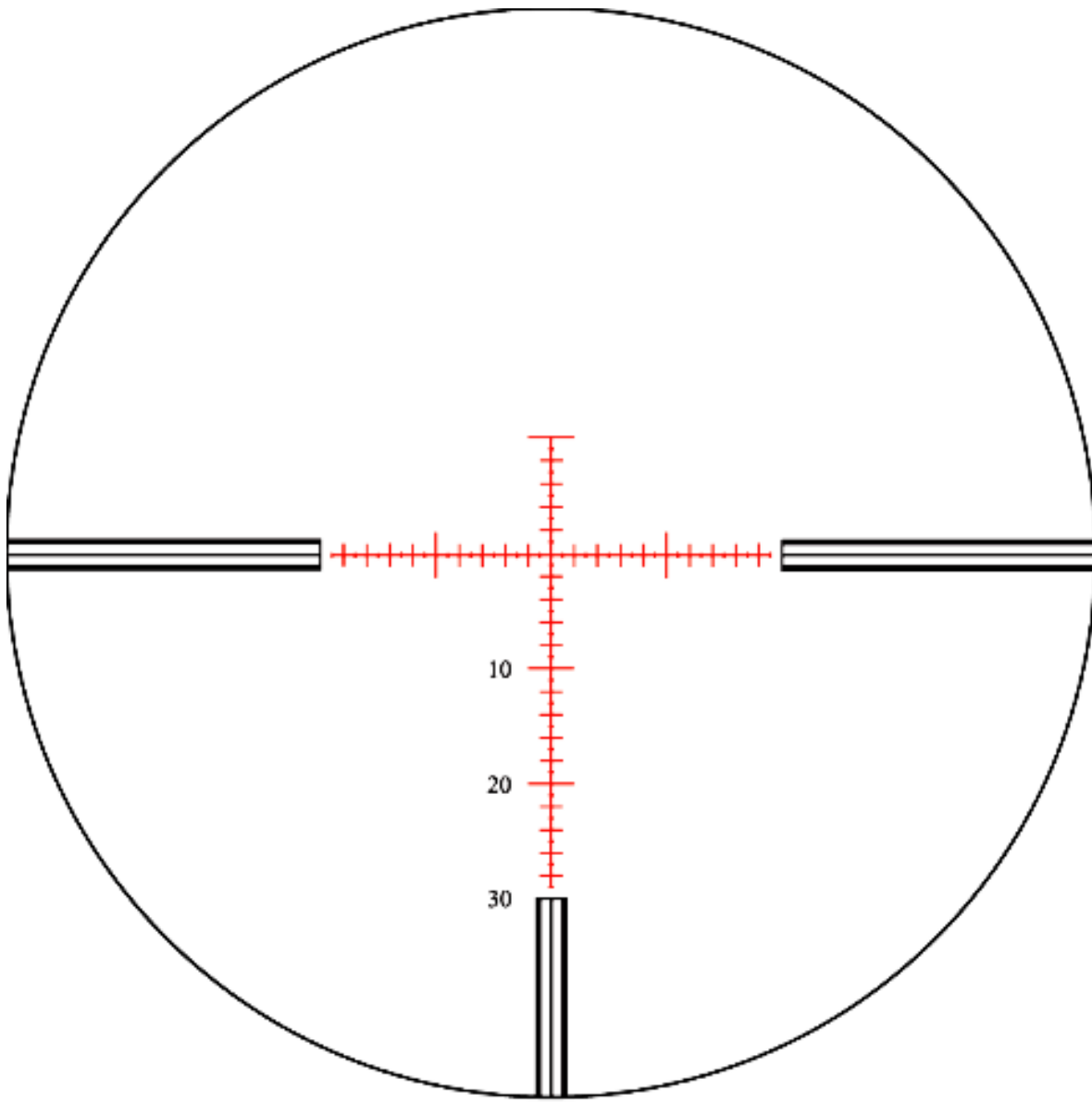

**2 MOA elevation and windage spacing are ideal for precision long-range shooting and all-around use. 10, 20 and 30 MOA elevation points are clearly marked for quick reference in the field. Especially suitable for range finding.**

# NightForce Reticle Patterns

## MD 2.0 Field Tactical

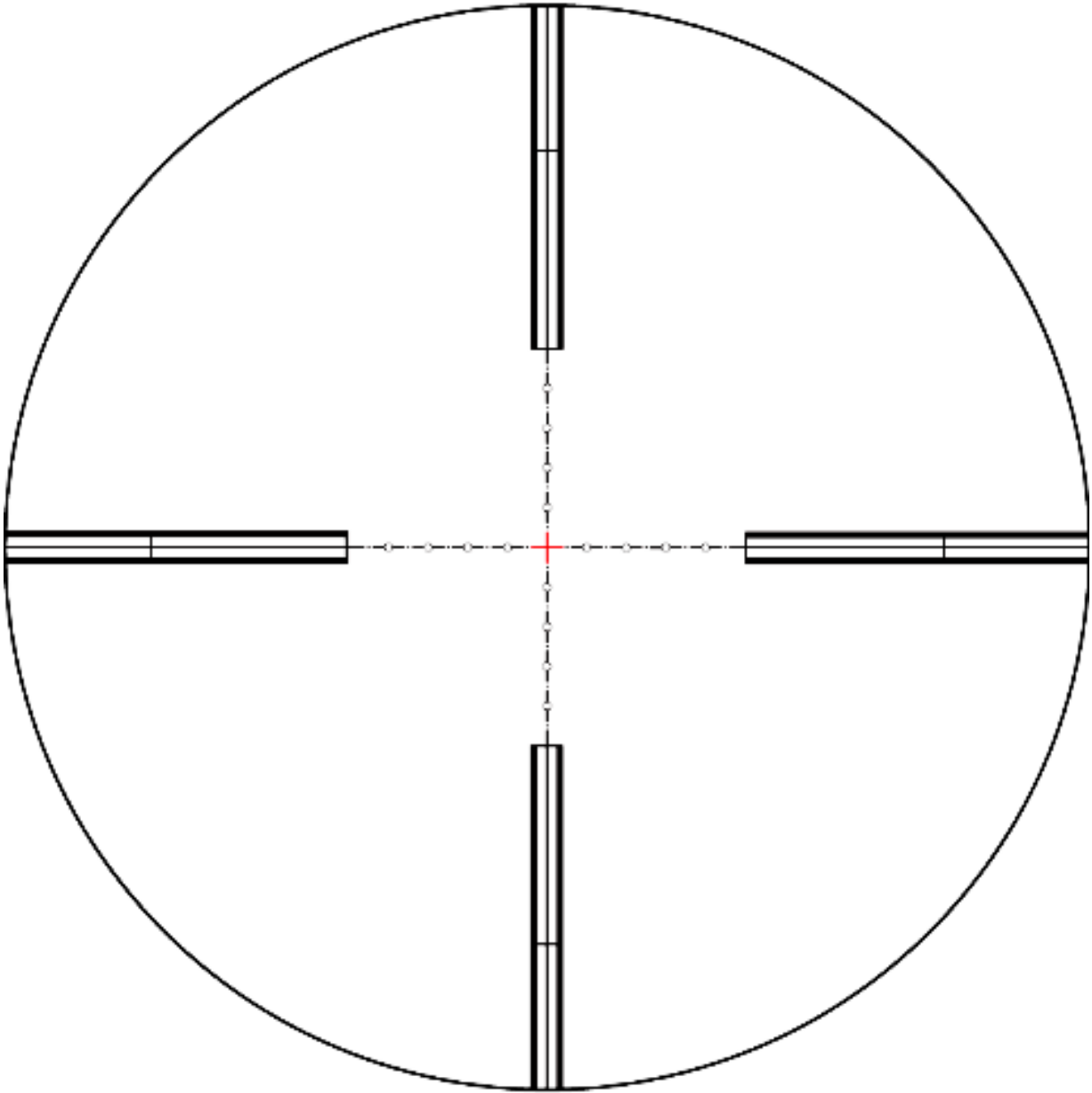

**1 mil spacing between dots. See-through design does not obscure small targets at long ranges. Four posts allow centering the target quickly, especially in poor light.** 34

# NightForce Reticle Patterns

## MLR2.0 Field Tactical Long Range

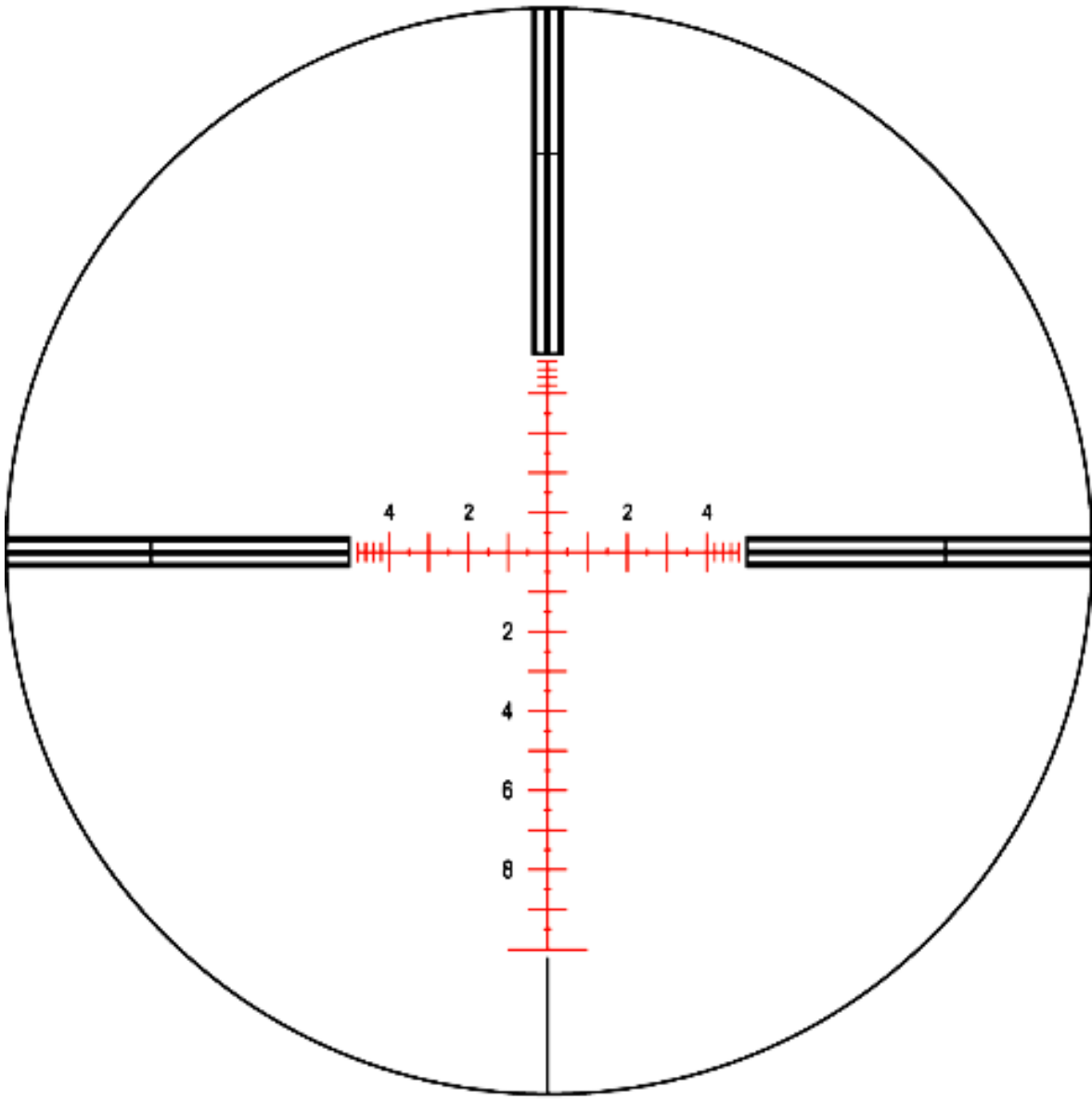

The .5 and 1 mil divisions allow for multiple zeroes, holdover, holdunder and windage adjustments without touching elevation or windage knobs. Elevation points are numerically identified in 2, 4, 6 and 8 mil increments, 35 windage points in 2 and 4 mil increments.

# NightForce Reticle Patterns

## General Velocity 1000

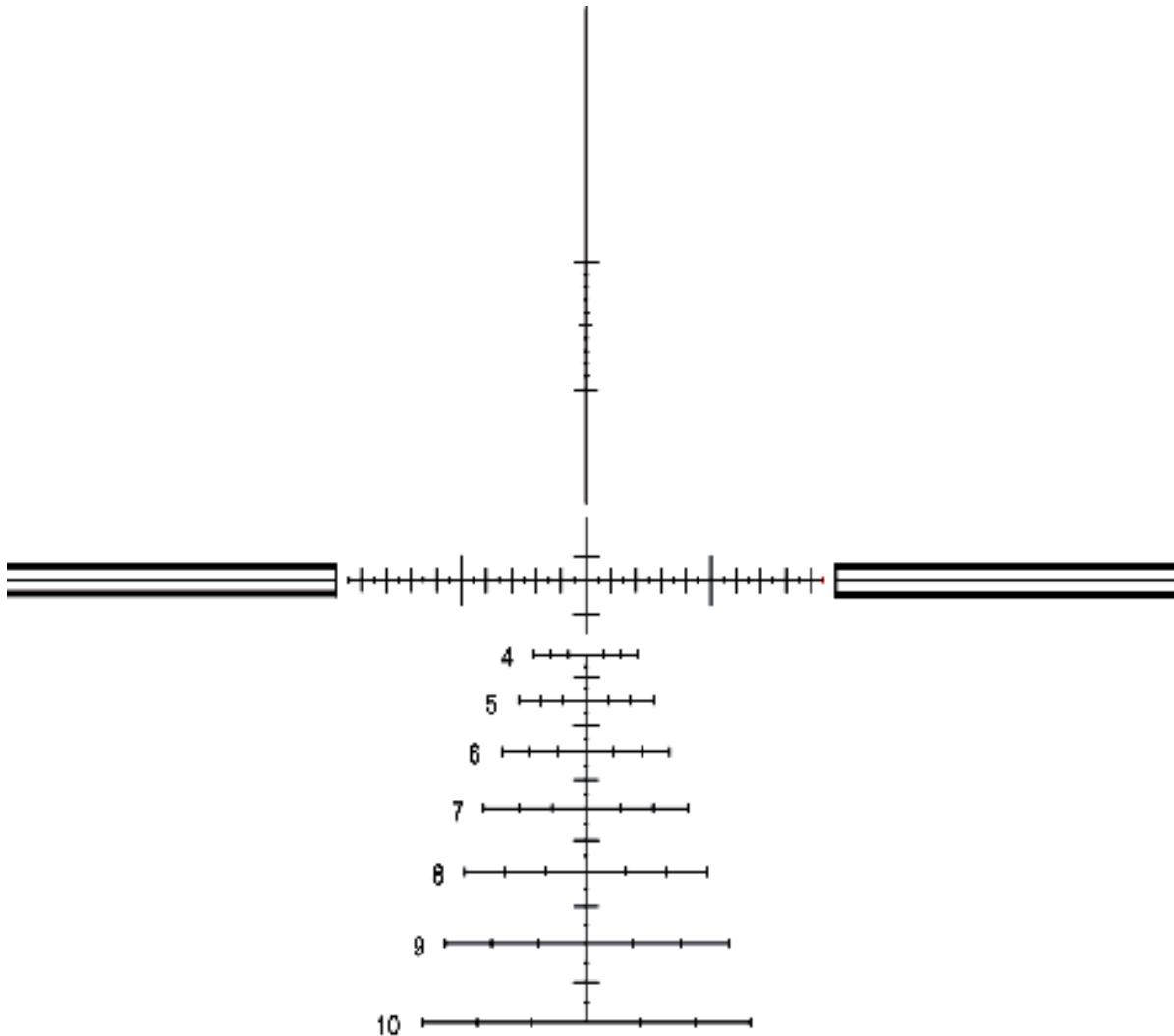

**Precise shot placement to 1000 yards with accurate holdovers. Available in LV.5, MV.5, HV, HV.5, HVM, HVM.5, UHV and UHV.5 configurations.**

# NightForce Reticle Patterns LV.5 General Long Range

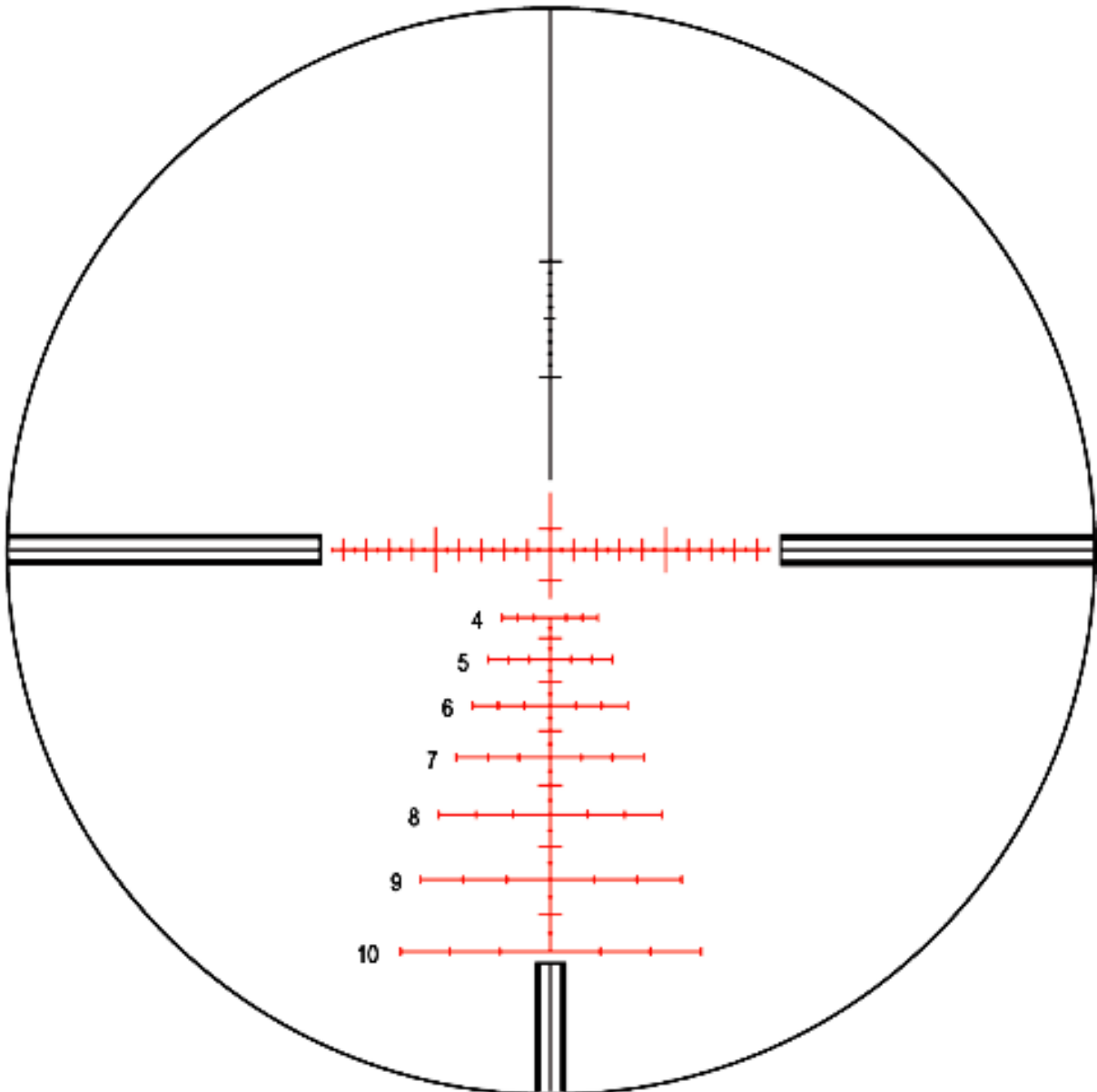

**Precise shot placement to 1000 yards with accurate holdovers when the distance to target is known. Extremely quick, requiring no calculation or adjustments. Designed for specific calibers and ballistic profiles.**

# NightForce Reticle Patterns MOAR

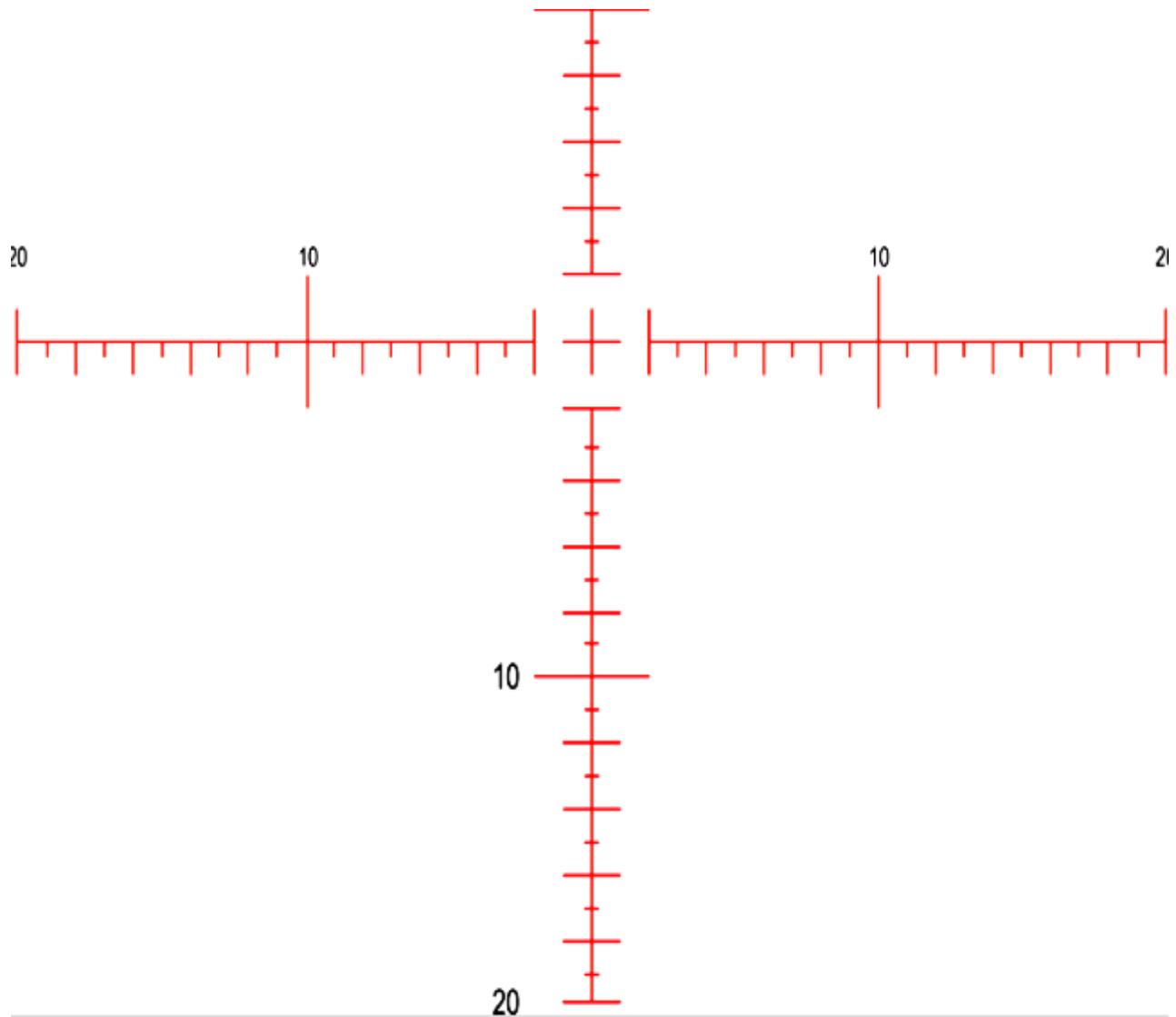

**With 1 MOA elevation and windage markings, more accurate range finding and hold-offs are possible on smaller targets at longer ranges. Combined with a floating center crosshair, this makes for a reticle extremely fast and easy to use in the field**

# NightForce Reticle Patterns NP-1RR

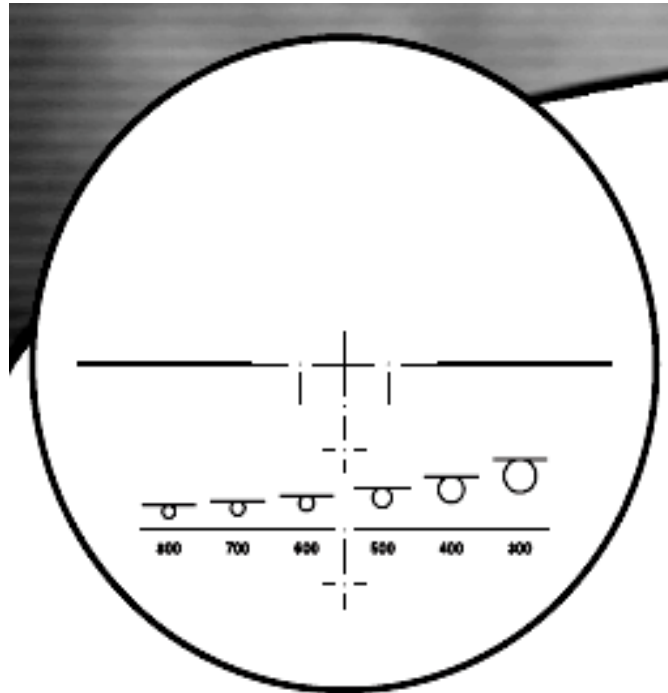

## NP-1RR

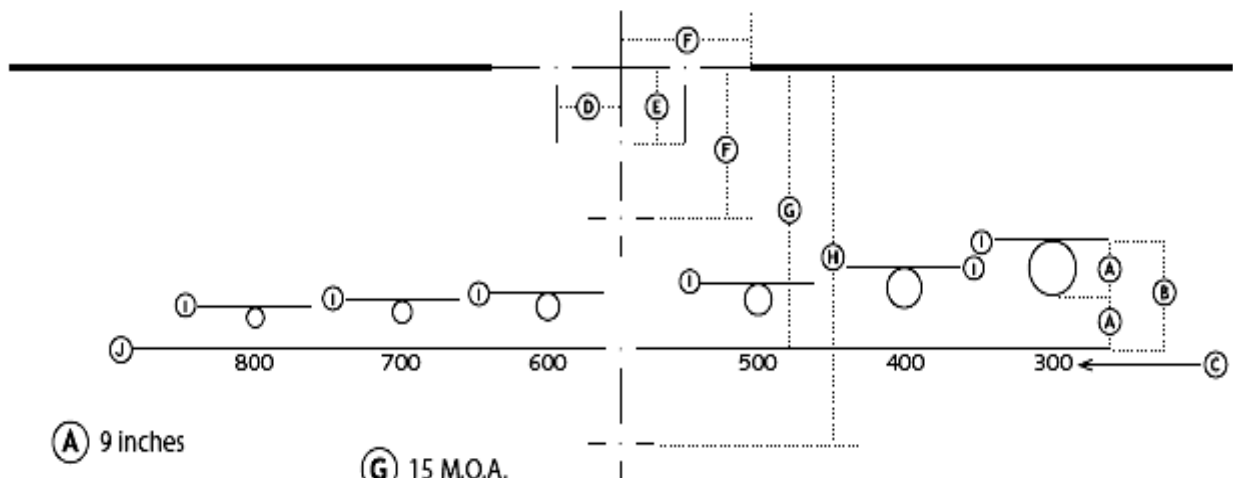

- (A) 9 inches
- (B) 18 inches
- (C) Distance in Yards
- (D) 4 M.O.A.
- (E) 4 M.O.A.
- (F) 8 M.O.A.
- (G) 15 M.O.A.
- (H) 20 M.O.A.
- (I) Step
- (J) Baseline

Binocular Model	Ranging Power
3.5-15x NXS	15x
5.5-22x NXS	22x
8-32x NXS and Benchrest	22x*
12-42x NXS and Benchrest	22x*
*Signified by an "R" on the Power Zoom Ring	

# NightForce Reticle Patterns MIL-DOT

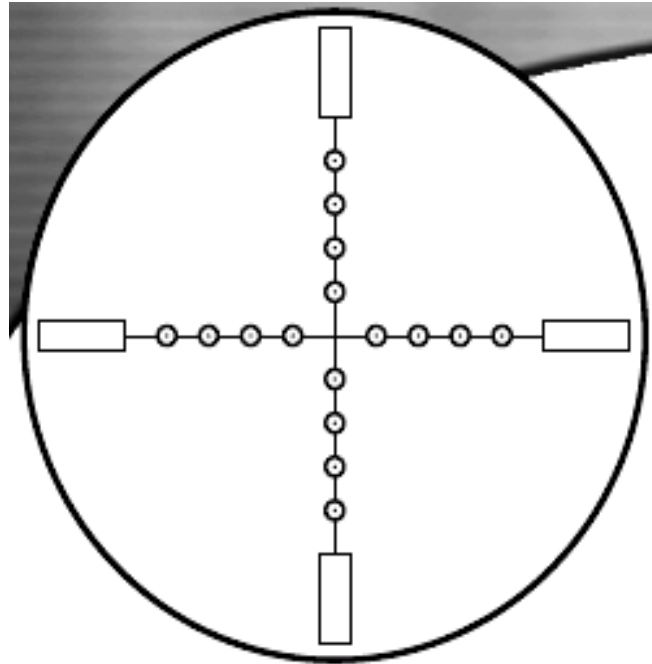

## MIL-DOT

**Suggested Use**  
Field tactical

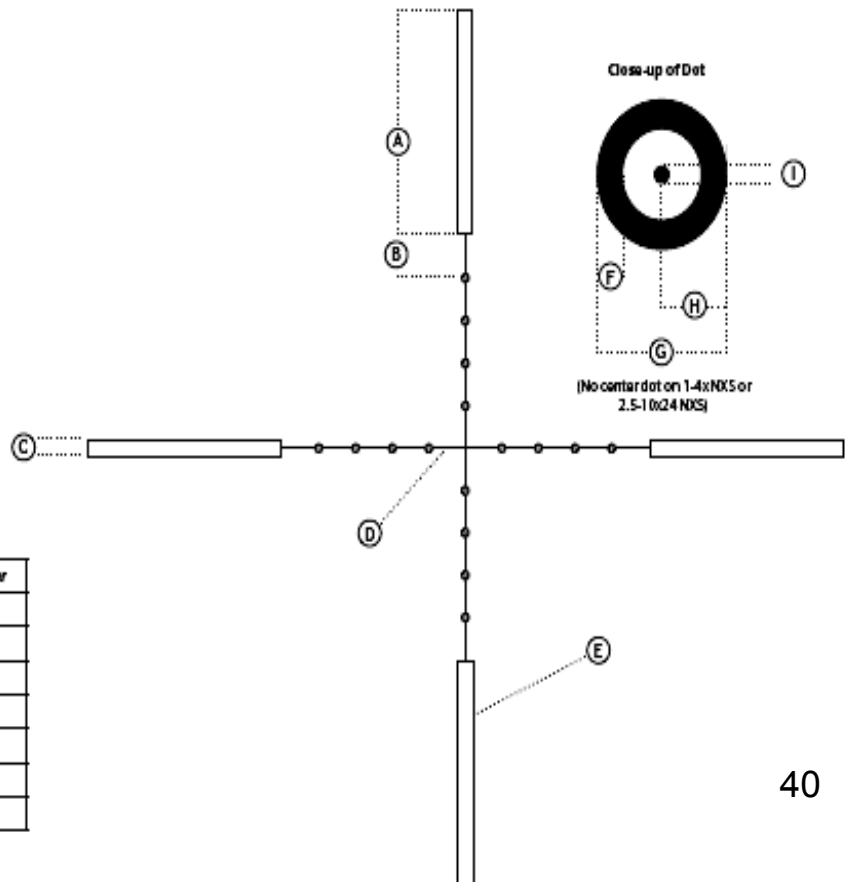

Binocular Model	Ranging Power
1-4x NXS	4x
2.5-10x NXS	10x
3.5-15x NXS	15x
5.5-22x NXS	22x
8-32x NXS and Benchrest	22x*
12-42x NXS and Benchrest	22x*

\*Signified by an "R" on the Power Zoom Ring



# NightForce Reticle Patterns NP-R2

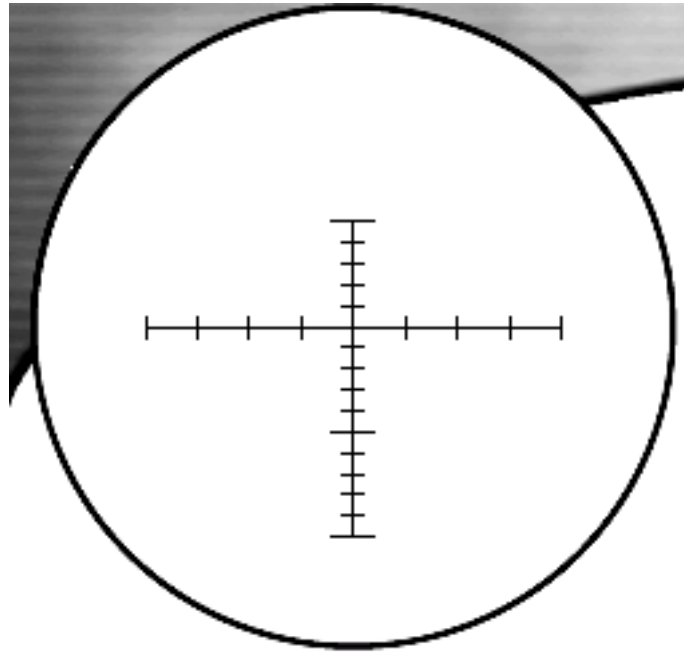

## NP-R2

- (A) 2 M.O.A.
- (B) 5 M.O.A.
- (C) 10 M.O.A.
- (D) 2 M.O.A.
- (E) 4 M.O.A.
- (F) 60 M.O.A. @ 10x, 60 M.O.A. @ 15x,  
40 M.O.A. @ 22x
- (G) 40 M.O.A. @ 10x, 40 M.O.A. @ 15x,  
30 M.O.A. @ 22x
- (H) Line Thickness - .09 M.O.A. @ 10x,  
.06 M.O.A. @ 15x, .06 M.O.A. @ 22x

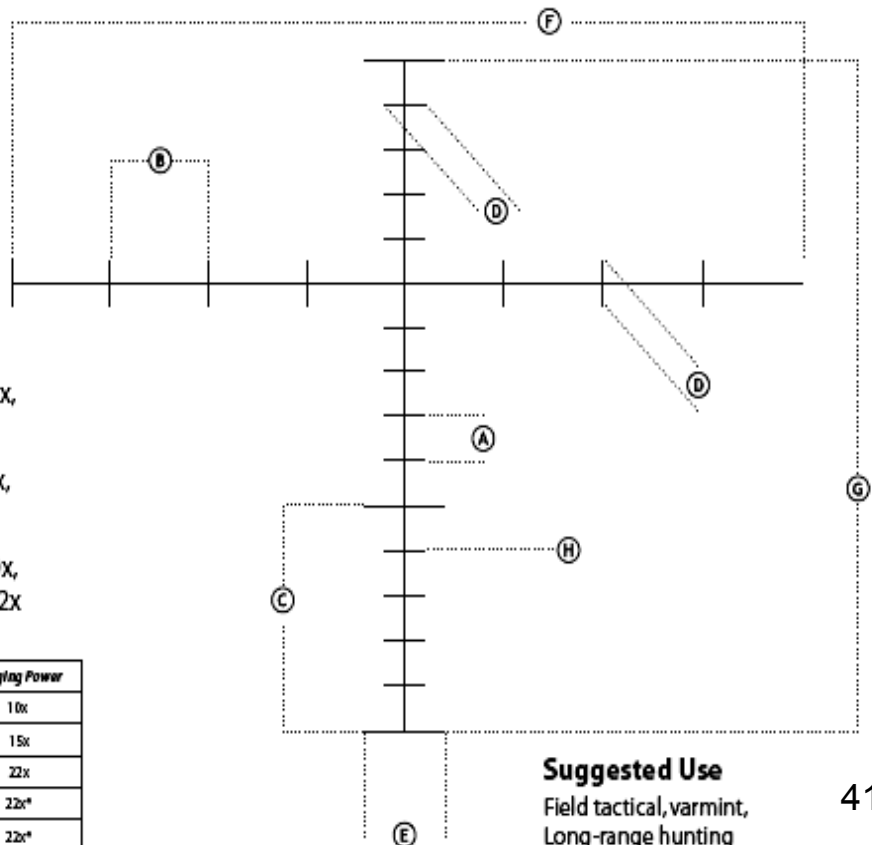

Binocular Model	Ranging Power
2.5-10x NXS	10x
3.5-15x NXS	15x
5.5-22x NXS	22x
8-32x NXS and Benchrest	22x*
12-42x NXS and Benchrest	22x*
*Signified by an "R" on the Power Zoom Ring	

**Suggested Use**  
Field tactical, varmint,  
Long-range hunting

# NightForce Reticle Patterns NP-1

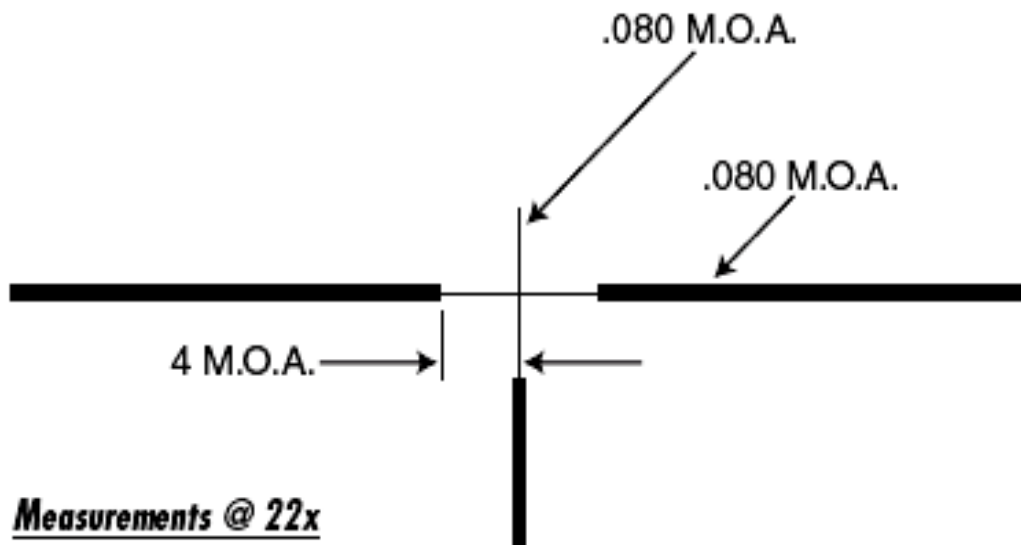
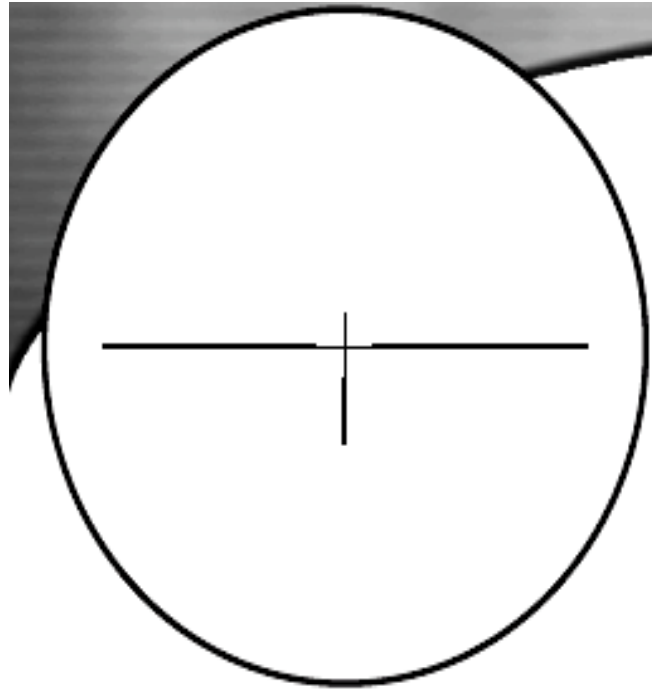

# NightForce Reticle Patterns

## NP-2DD

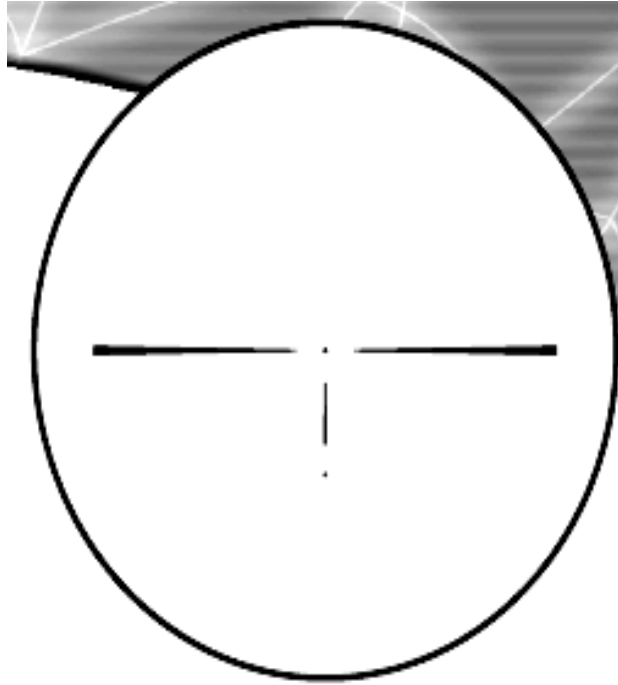

### NP-2DD

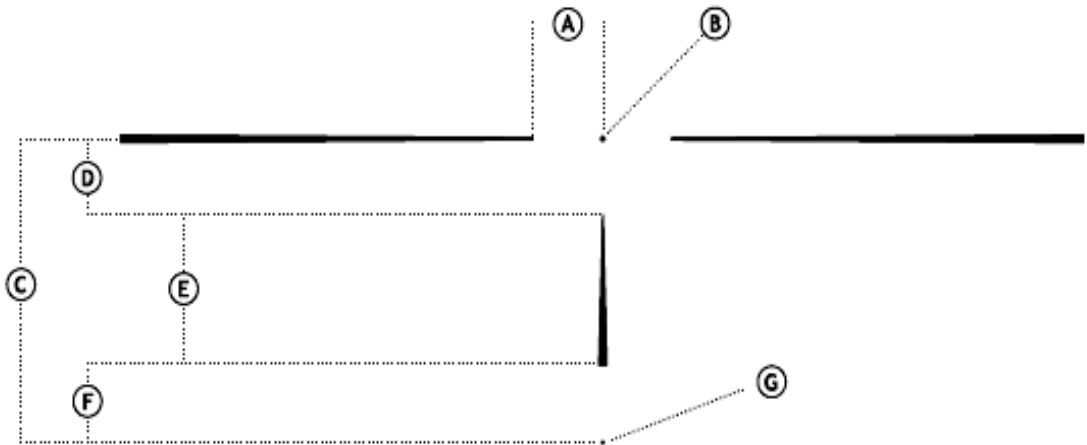

Binocular Model	Ranging Power
3.5-15x NXS	15x
5.5-22x NXS	22x
8-32x NXS and Benchrest	22x*
12-42x NXS and Benchrest	22x*
*Signified by an "R" on the Power Zoom Ring	

### Suggested Use

Varmint, 1000 yard benchrest

# NightForce Reticle Patterns

## CH-1 & CH-2

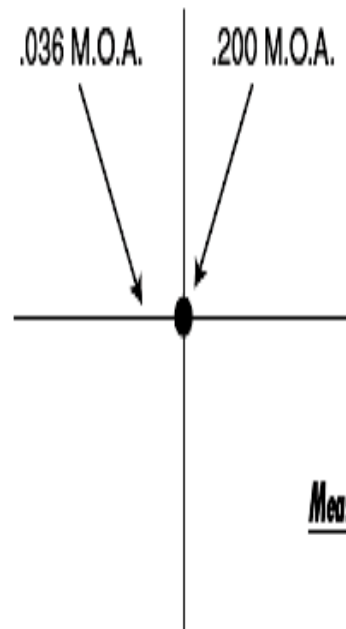
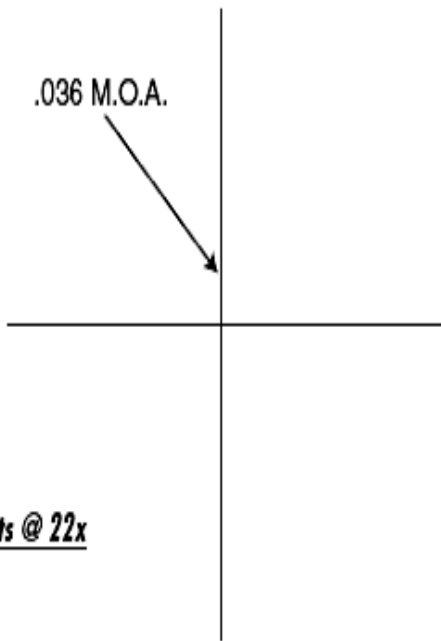
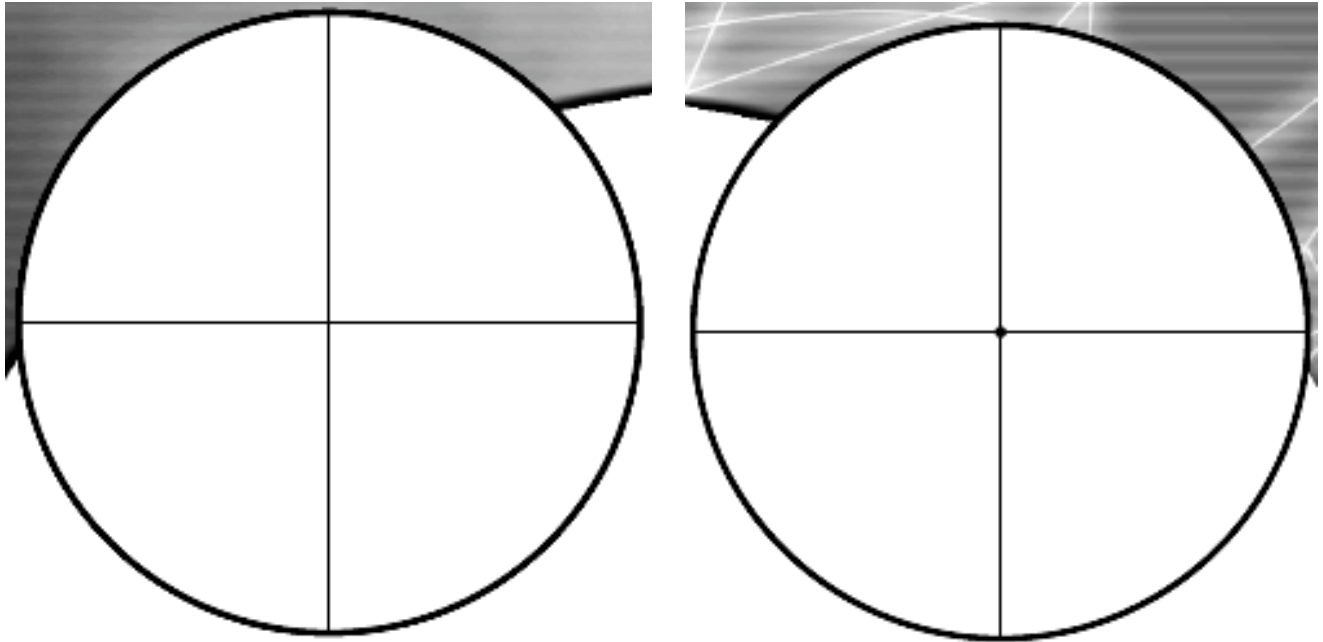

# NightForce Reticle Patterns CH-3

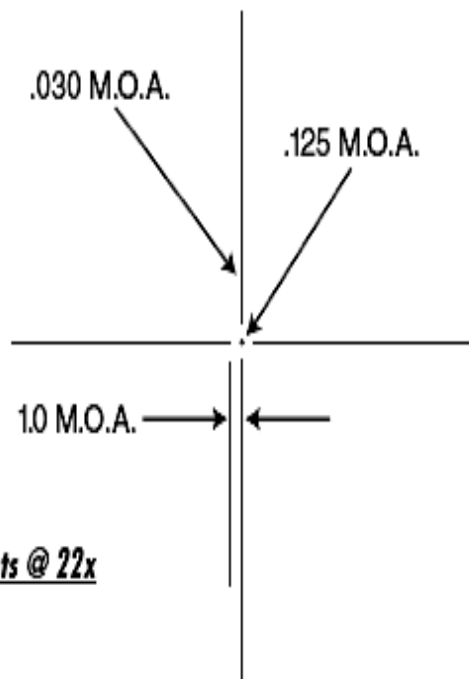
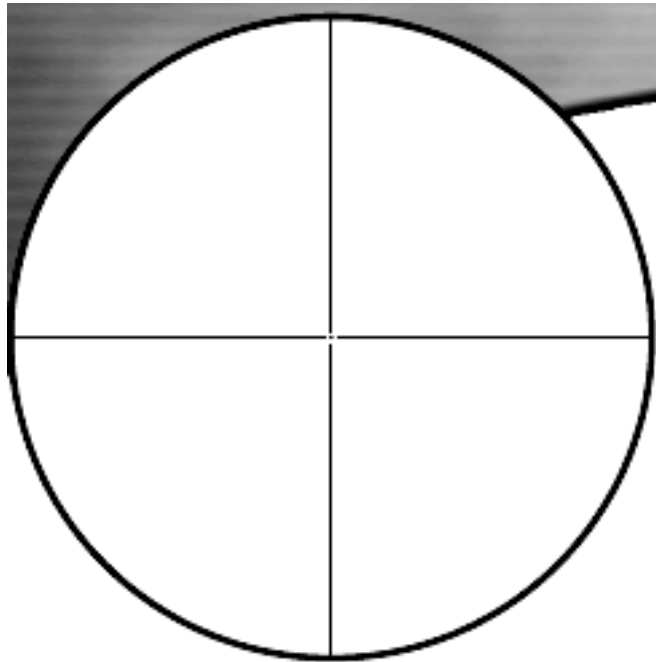

**Measurements @ 22x**

# NightForce Reticle Patterns

## MLR & FC-2

### MLR

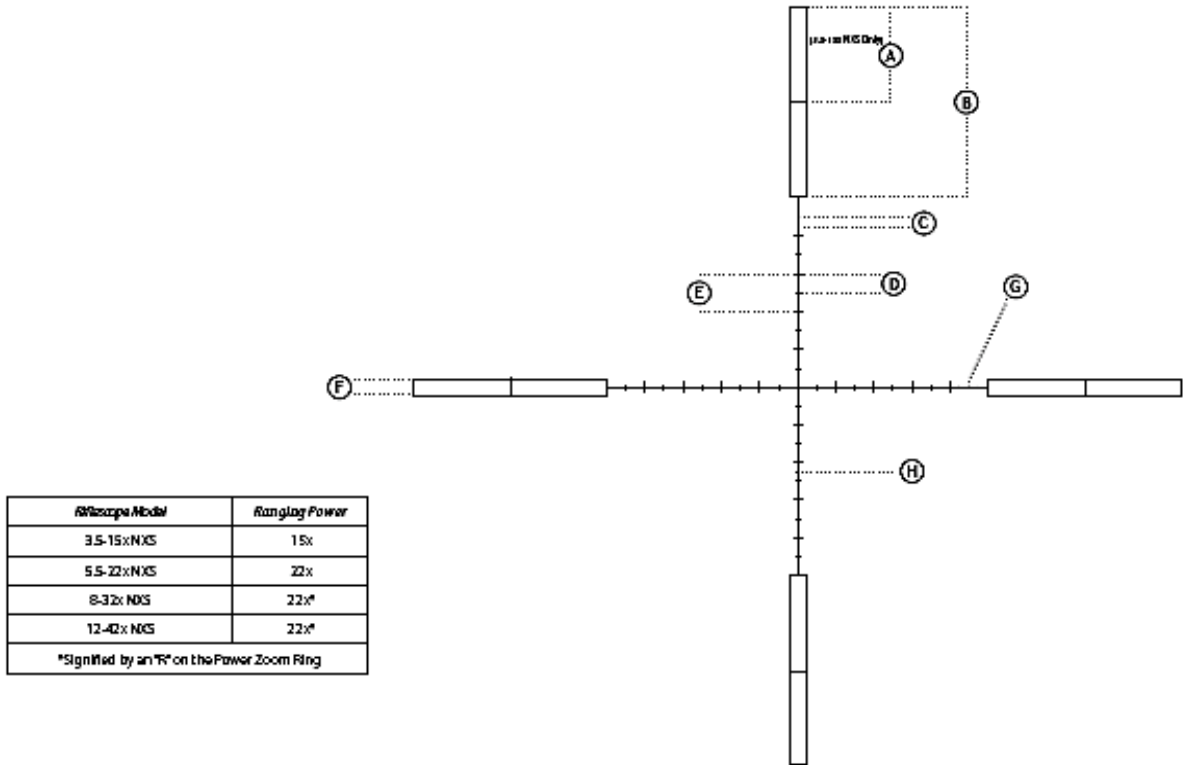

Riflescope Model	Ranging Power
3.5-15x NXS	15x
5.5-22x NXS	22x
8-32x NXS	22x*
12-42x NXS	22x*

\*Signified by an 'R' on the Power Zoom Ring

The triangular aiming point under the circle can be used as a 10 M.O.A. holdover point from the center dot, and as a ranging tool in combination with the circle and dot.

**A** 10 M.O.A.

**B** 2 M.O.A. for 1-4x, 1.5 M.O.A. - for 2.5-10x

**C** 5 M.O.A.

**D** 5 M.O.A.

**E** 15 M.O.A.

**F** 40 M.O.A. for 1-4x, 30 M.O.A. for 2.5-10x

**G** Line Thickness = .50 M.O.A. @ 4x, 30 M.O.A. @ 10x

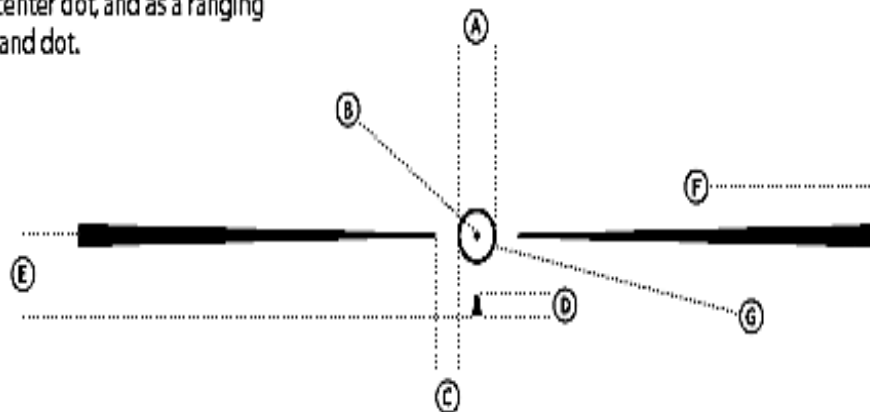

Riflescope Model	Ranging Power
1-4x NXS	4x
2.5-10x NXS	10x

### Suggested Use

CQB, hunting

# NightForce Reticle Patterns NP-R1

**NP-R1**

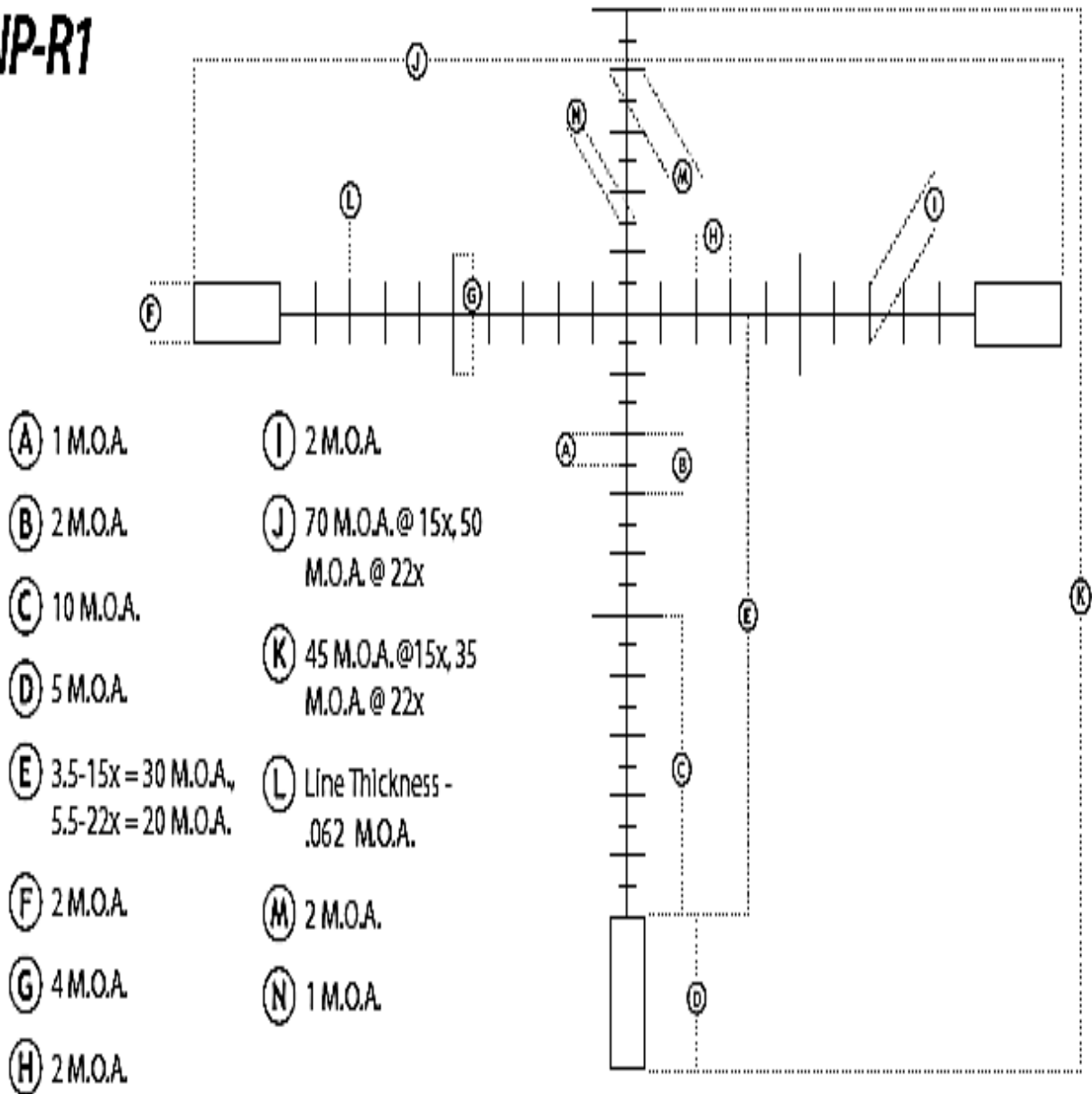

# David Tubb/Brand Cole DTAC Reticle Pattern

(inc. Aiming Dots/Mil Stadia, Density Altitude Graph, Range Calculation Graph)

- ❶ Aiming Dots and Correction Pointers  
(pointers located on aiming dots)
- ❷ MIL Measuring Stadia
- ❸ Scope Legend
- ❹ Density Altitude Graph
- ❺ Range Calculation Graph
- ❻ Levelling Reference

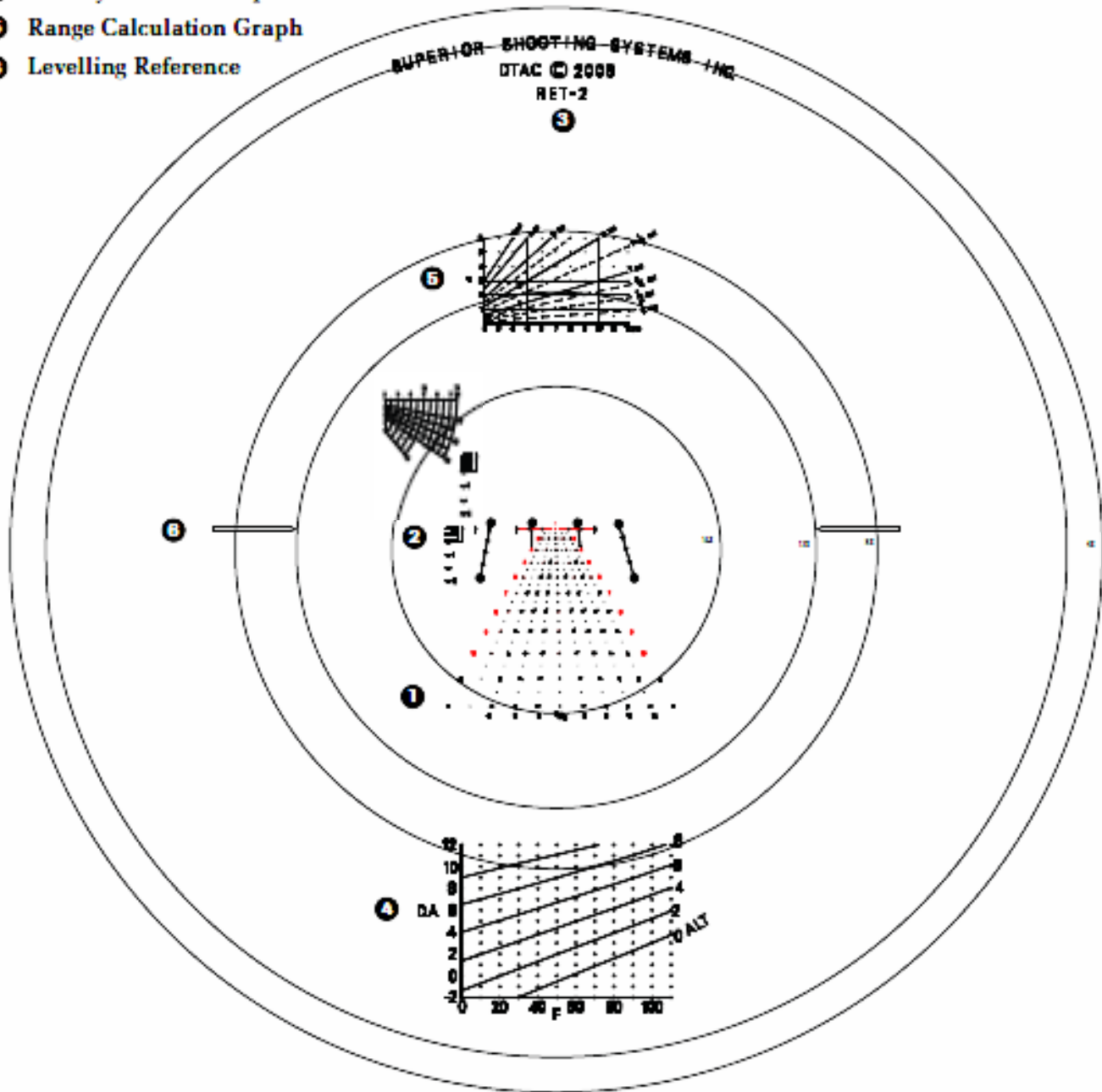



# David Tubb/Brand Cole DTAC Reticule Pattern @ 16x

(inc. Aiming Dots/Mil Stadia, Density Altitude Graph, Range Calc Graph, Cos/Sin Graph, Density Correction Graph)

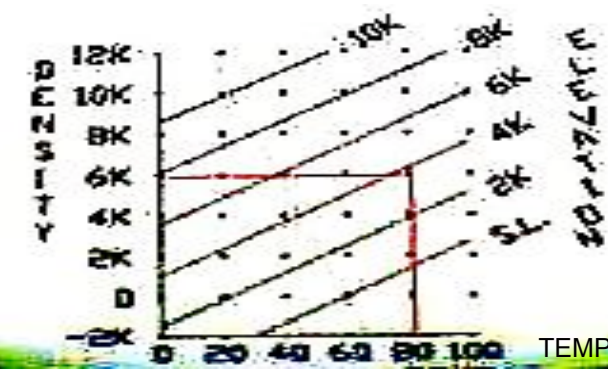
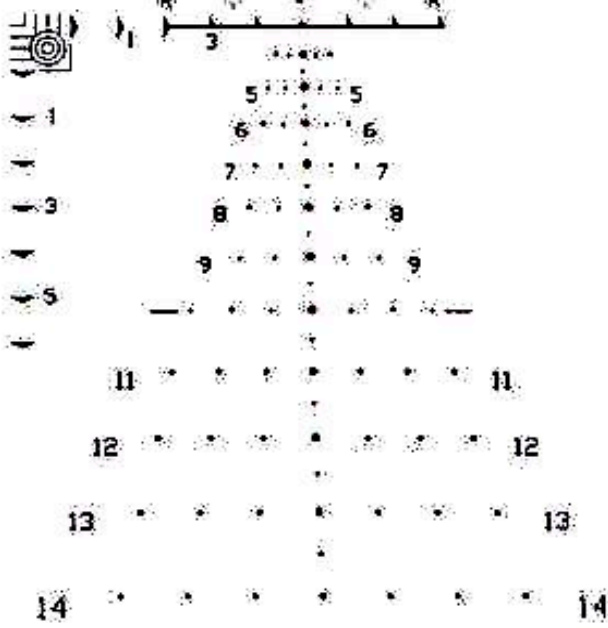
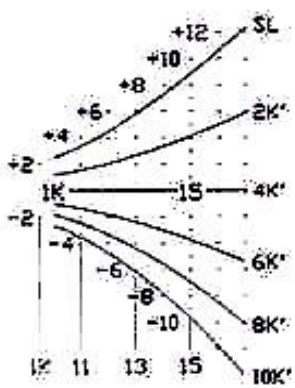
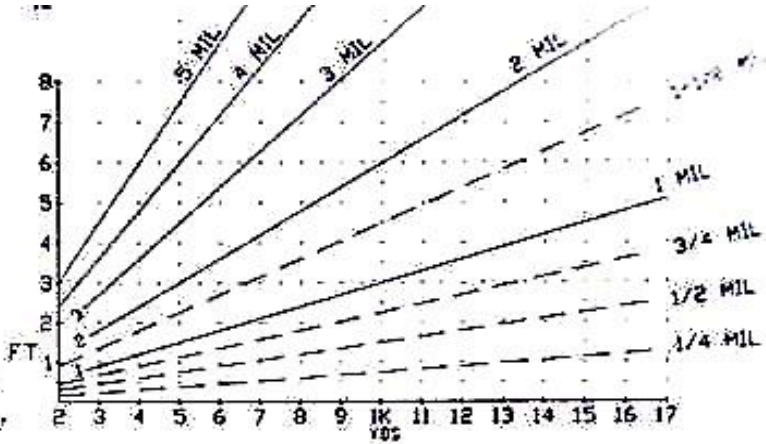
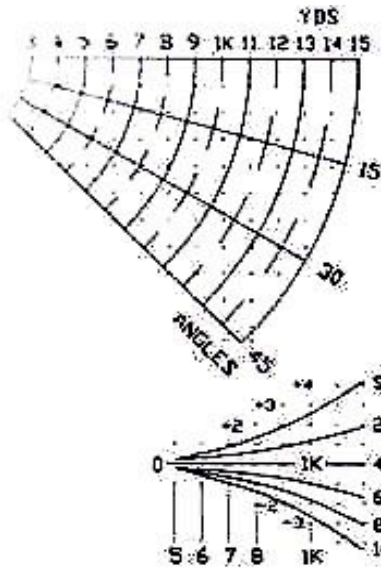

D-TAC  
 115 GR 6XC  
 4000' DENS ALT  
 Patent Pending  
 Rev. 3

From actual TEMP go UP to ELEVATION line then LEFT to DENSITY

# Premier Reticle Patterns



**#1 – German Post**

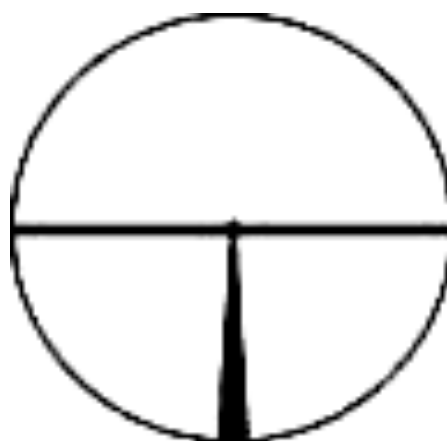

**#2 – Post & Crosshair**

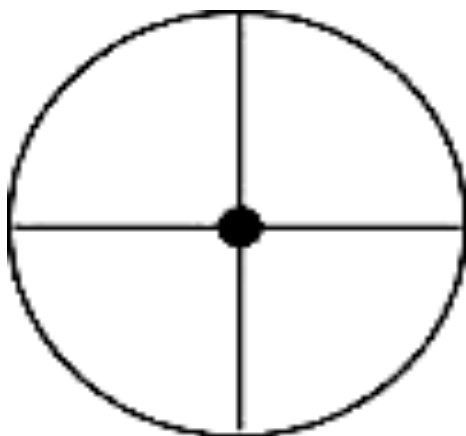

**#3 – Dot & Crosshair**



**#4 – 3 Post & Crosshair**



**#5 – Duplex**

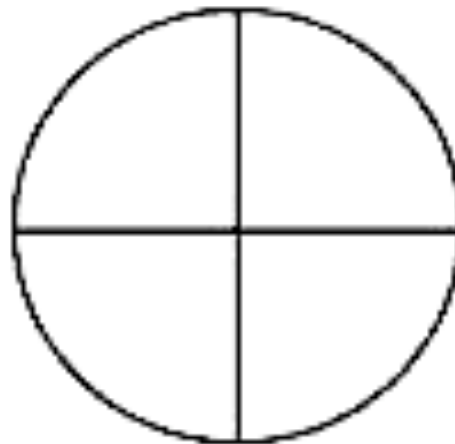

**#6 – Crosshair**

# Premier Reticle Patterns

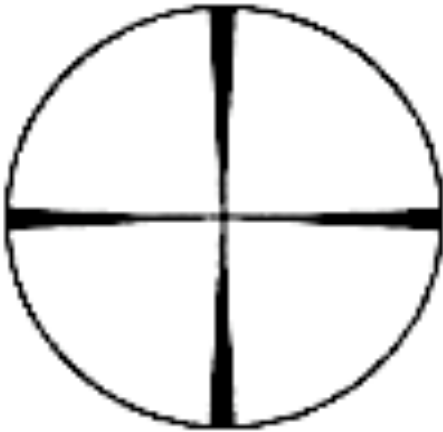

**#7 – CPC Tapering**

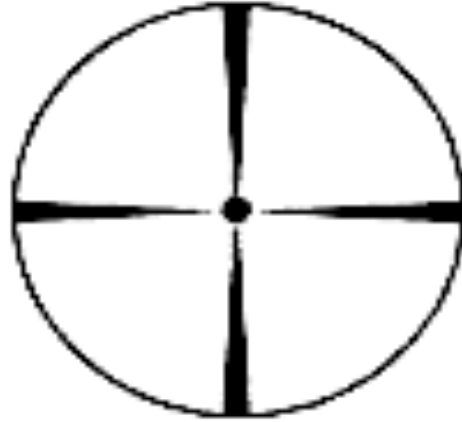

**#9 – Leupold Dot**

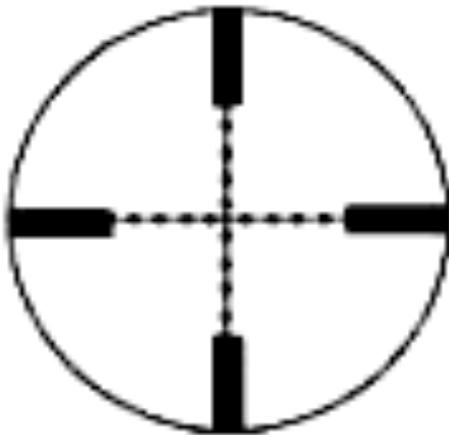

**#10 – Std Mil Dot**

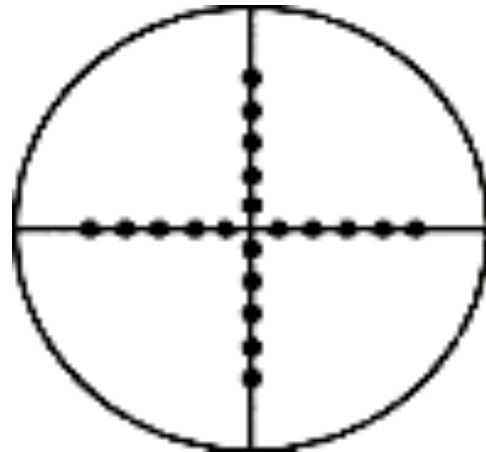

**#10a – Modified Mil Dot**

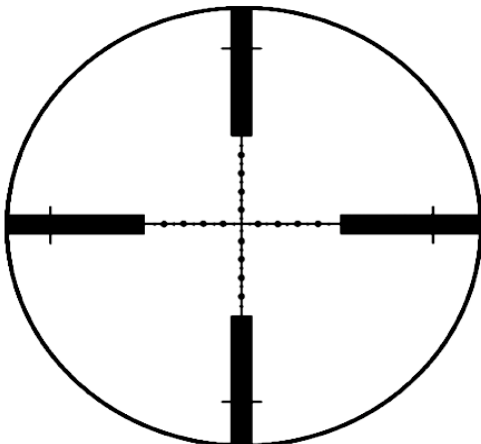

**Gen 2 Mil Dot**

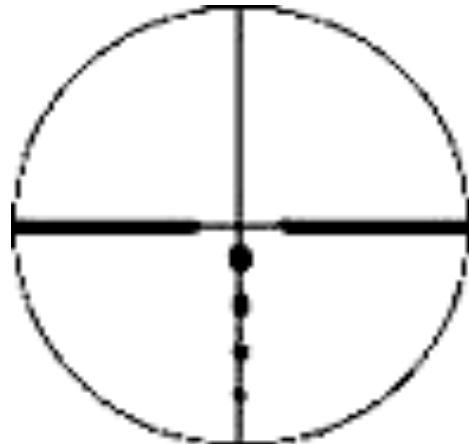

**Range Compensating**

# Premier Reticle Patterns

## Premier Gen 2 Mil Dot

### Gen 2 Mil-Dot

3-12x PML

1st focal plane

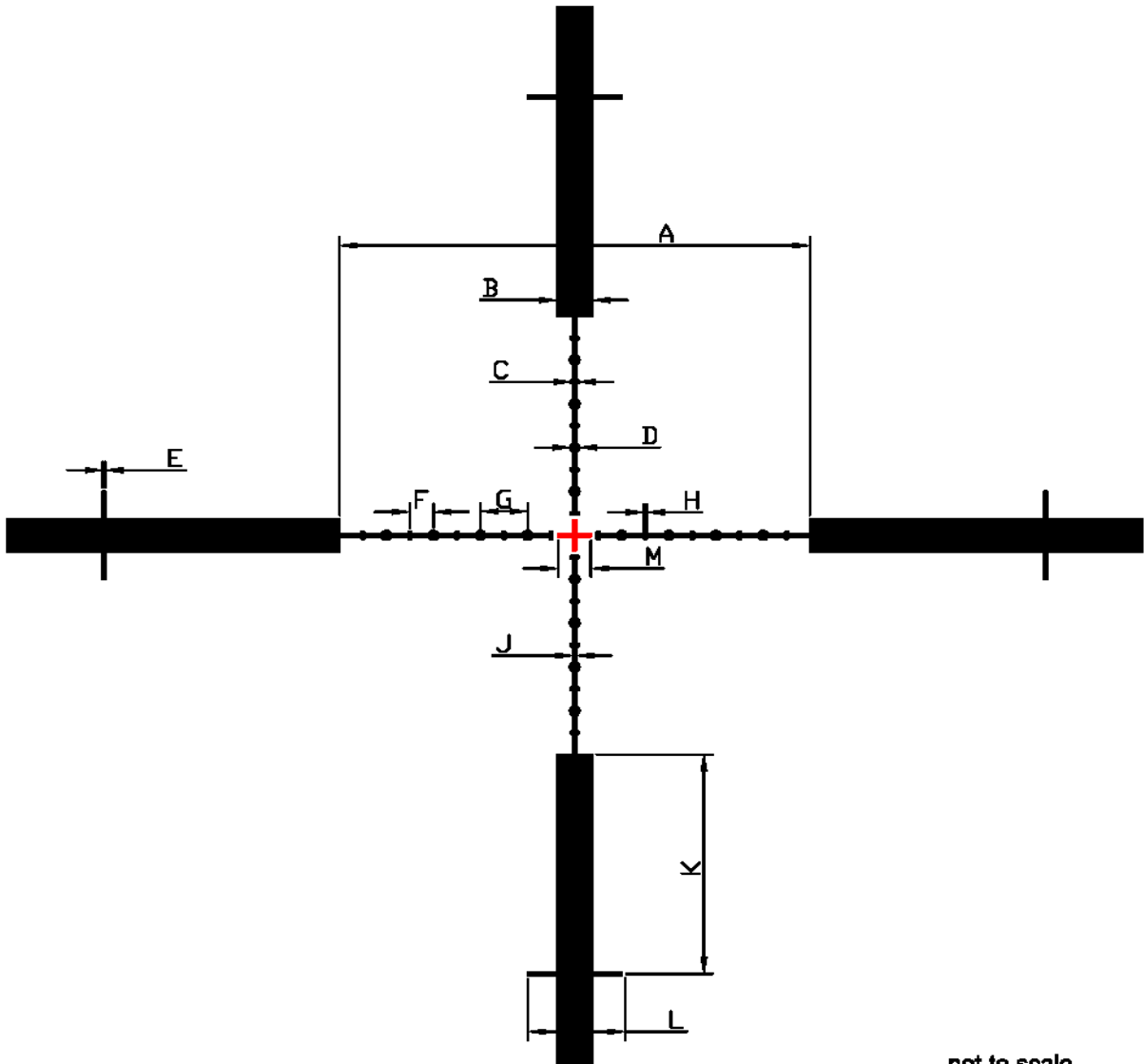

not to scale  
10/2007

Units	A	B	C	D	E	F	G	H	J	K	L	M
mrاد	10	0.75	0.15	0.2	0.06	0.5	1	0.06	0.06	5	2	0.56
ln/100yd	36	2.7	0.54	0.72	0.216	1.8	3.6	0.216	0.216	18	7.2	2.0
cm/100m	100	7.5	1.5	2	0.6	5	10	0.6	0.6	50	20	5.6

# Premier Reticle Patterns

## Premier Gen 2 Extreme Range

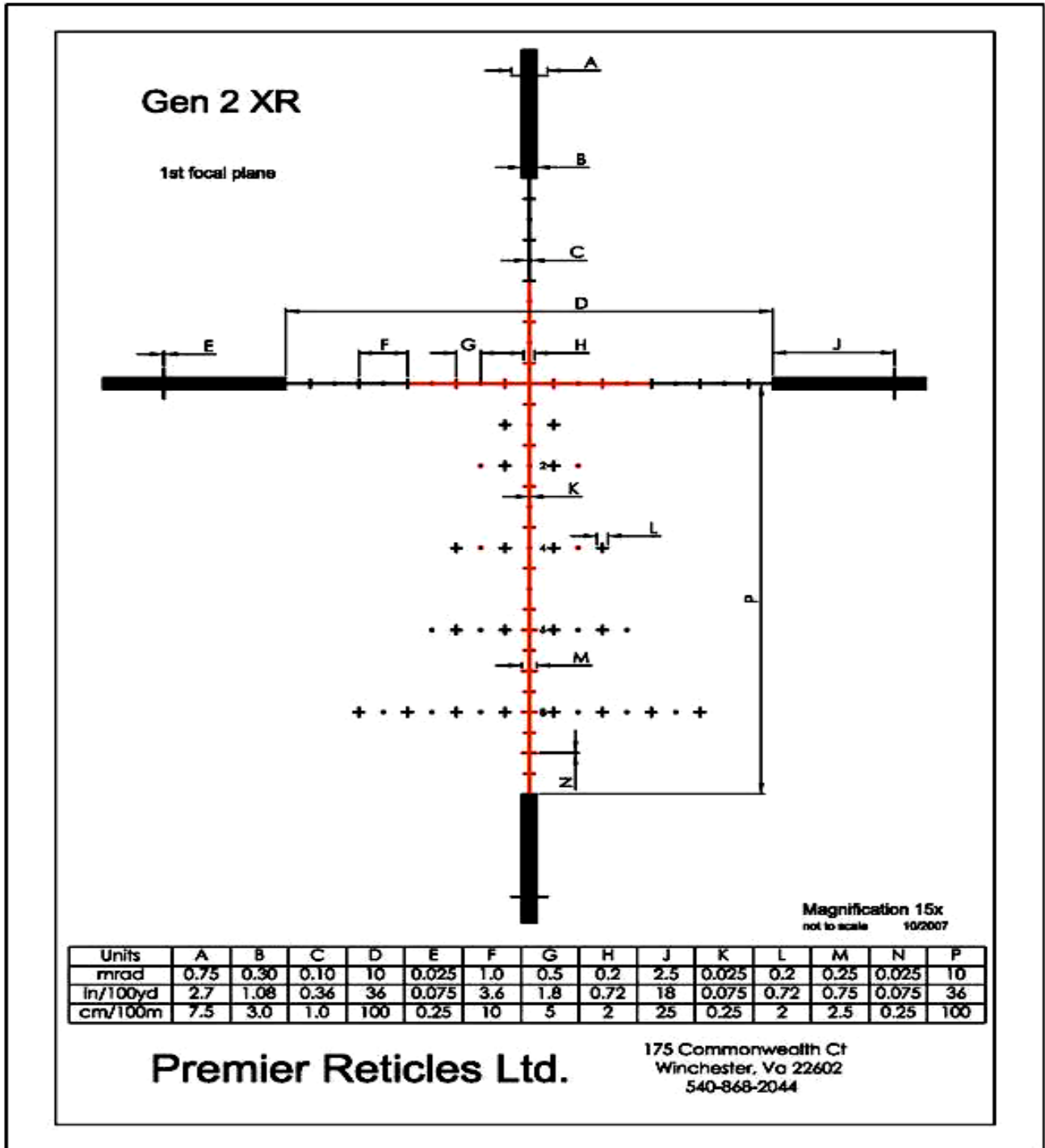

# Vortex Razor HD EBR-556 Close Quarters Reticle

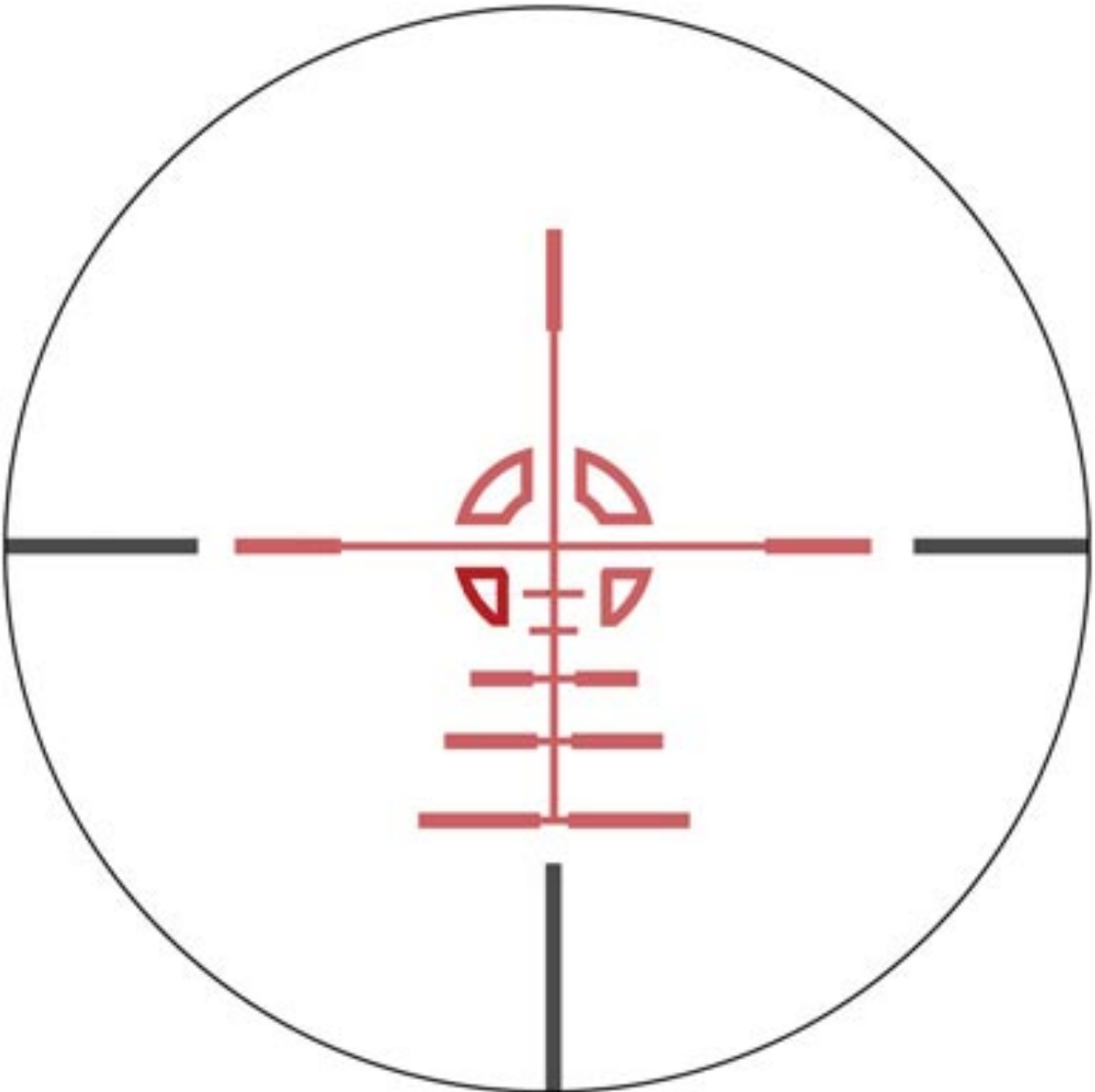

Configuration shown for 1-4x24 Vortex Razor HD 30mm Scope

# Vortex Razor HD EBR-2 MRAD Reticle

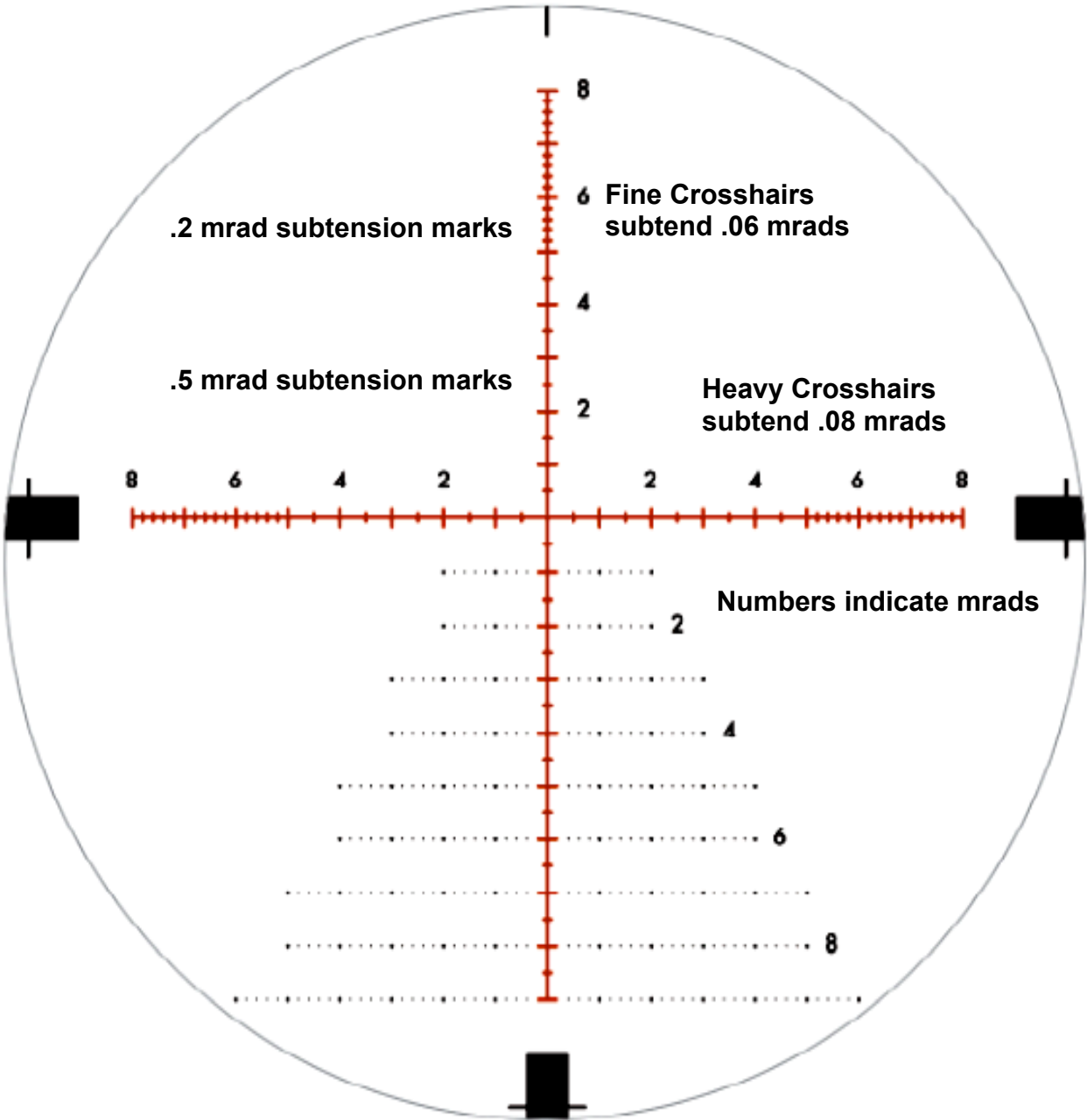

# Vortex Razor HD

## EBR-2 MRAD Reticle Ranging Examples

[Target Size (Meters) x 1000]/mrads Read = Range(Meters)  
[Target Size (Yards) x 1000]/mrads Read = Range (Yards)  
[Target Size (Inches) x 27.77]/mrads Read = Range (Yards)

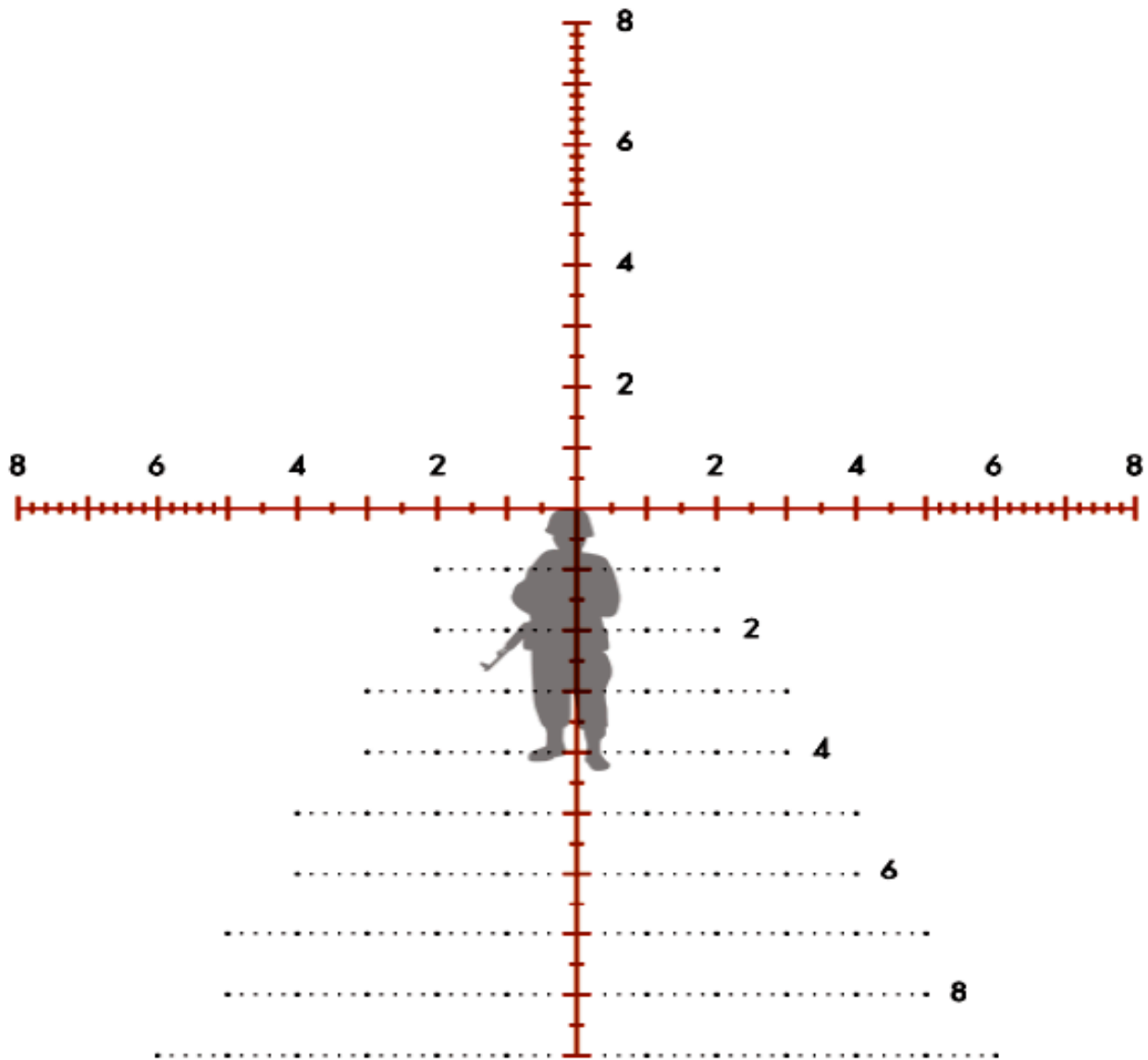

*Ranging a 6-foot figure (2 yards) at 4 mrads to get 500 yards.*

$$[2 \times 1000]/4 \text{ mrads} = 500 \text{ Yards}$$



# Vortex Razor HD EBR-2 MRAD Reticle Ranging Examples

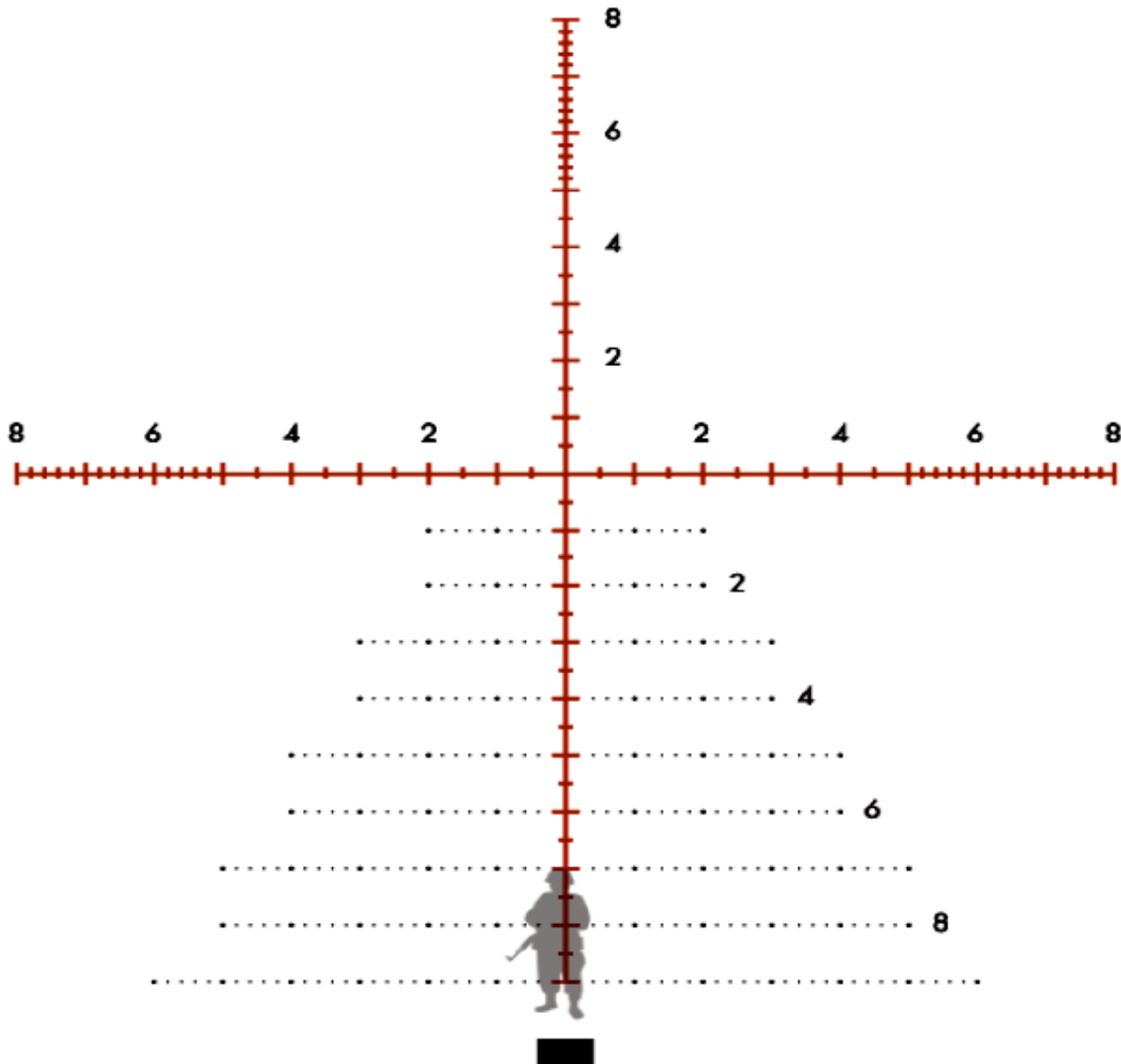

***7.7 mrad reticle holdover correction for 800 yard shot using 7.62mm with 175 gr. SMK. No wind.***

# Vortex Razor HD EBR-2 MRAD Reticle Ranging Examples

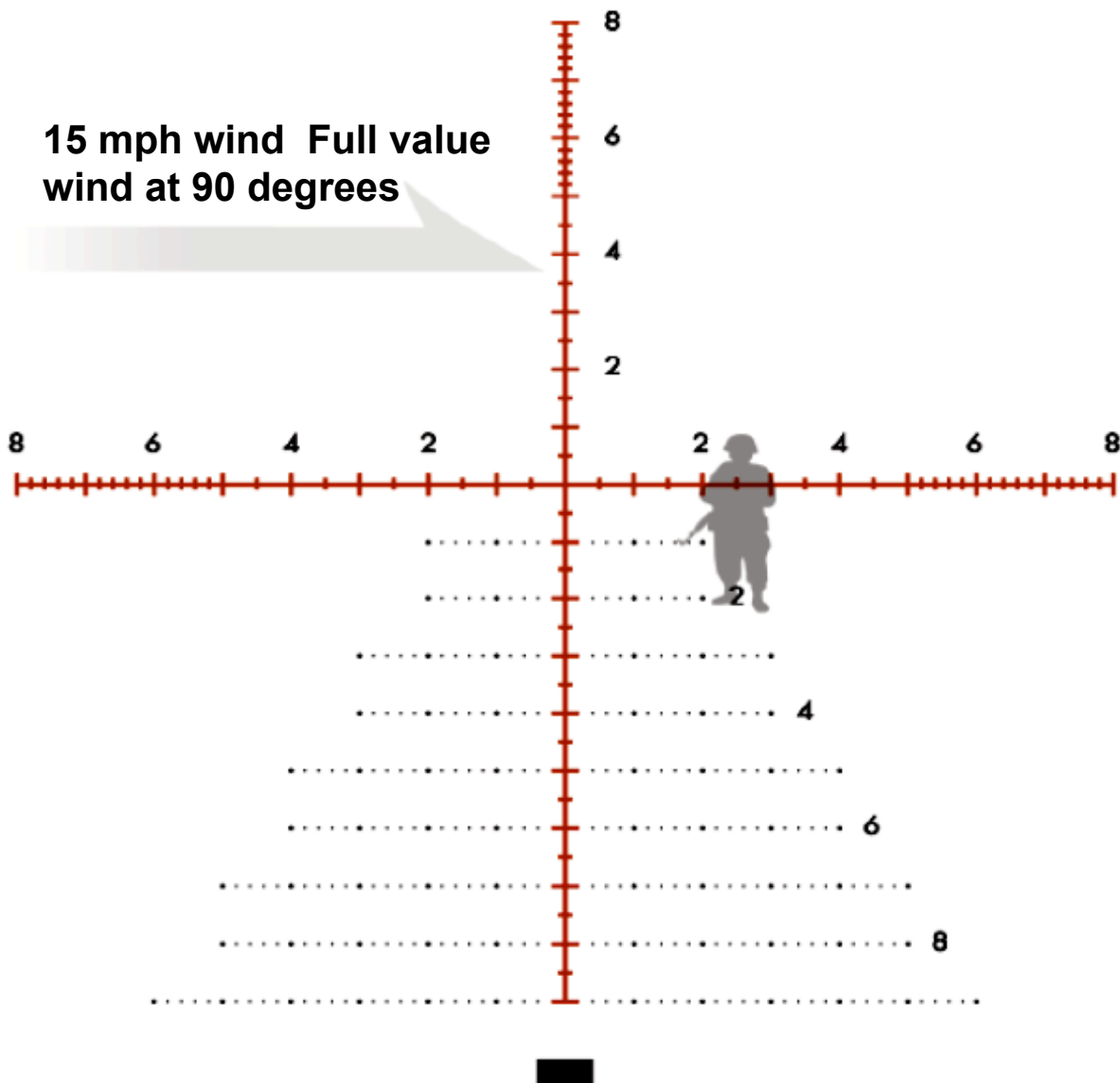

***2.6 mrad reticle correction for 15 mph wind at 700 yards using 7.62mm with 175 gr. SMK. Elevation already dialed into turret.***

# Vortex Razor HD EBR-2 MRAD Reticle Ranging Examples

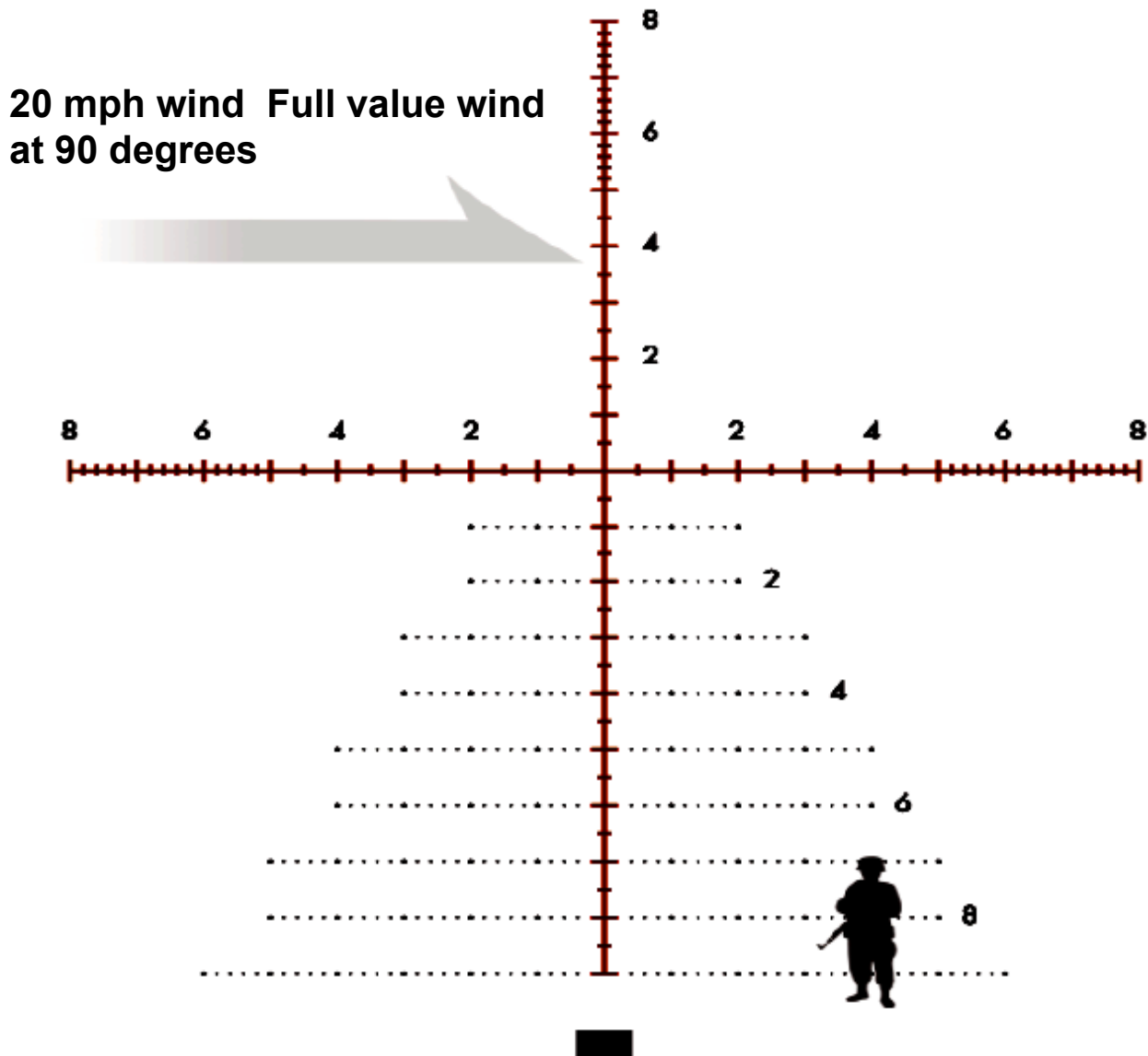

***4.2 mrad reticle windage correction for 20 mph wind at 800 yards with 7.62mm with 175 gr. SMK using 7.7 mrad reticle drop line.***

# Vortex Razor HD EBR-2 MRAD Reticle Ranging Examples

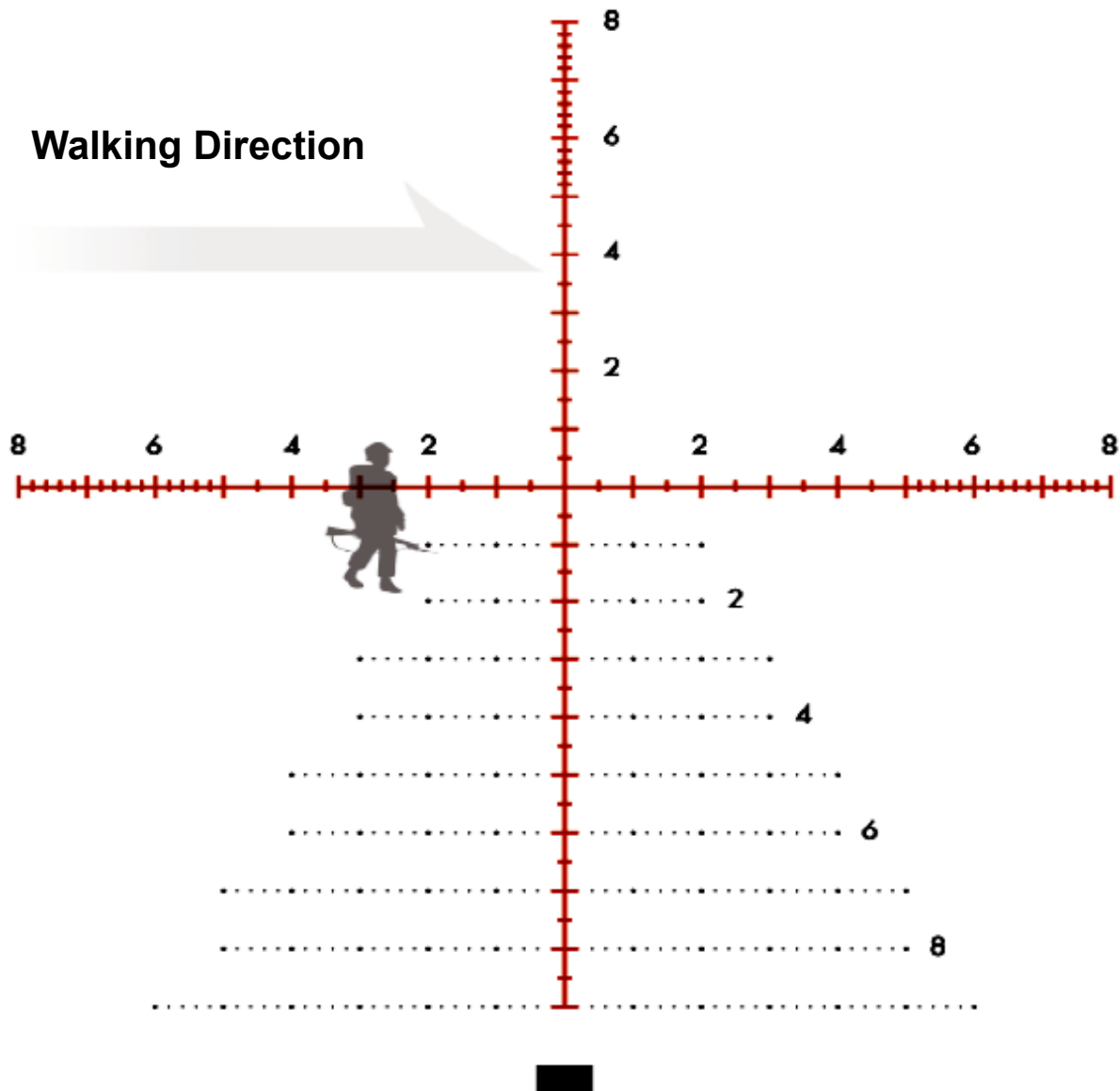

***2.74 mrad reticle correction for a figure walking 3 mph at a distance of 800 yards. 7.62mm with 175 gr. SMK. No wind. Total bullet time of flight from moment of trigger pull is 1.5 seconds during which the figure travels 6.6 feet. Elevation already dialed into turret.***

# IOR Valdada Reticle Patterns

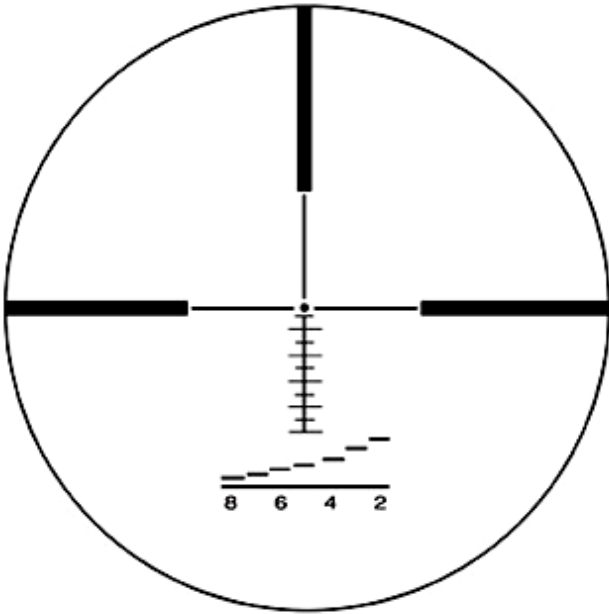

**HR5**

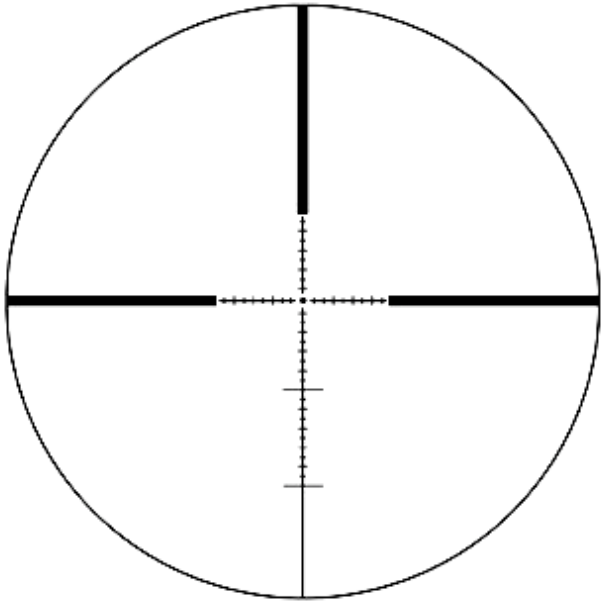

**MP-8 Dot**

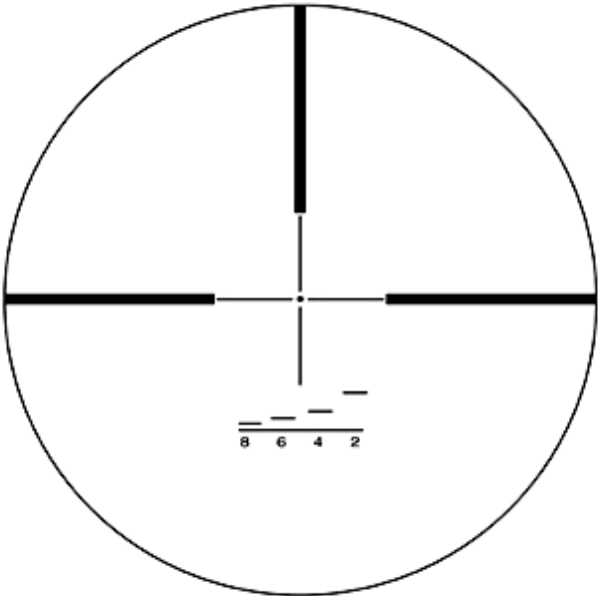

**NATO**

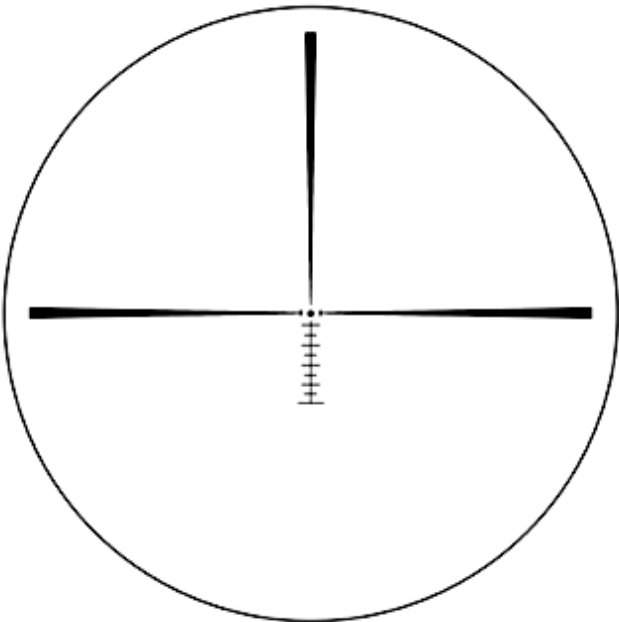

**VRM Varmint**

# IOR Valdada Reticle Patterns

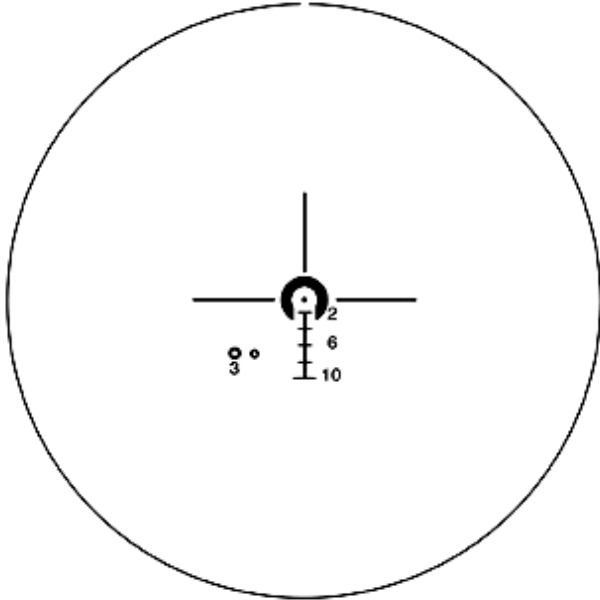

**3x25**

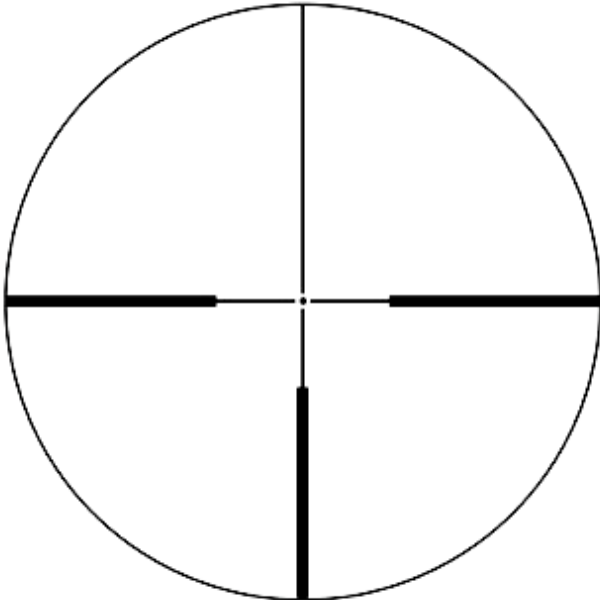

**4A Dot**

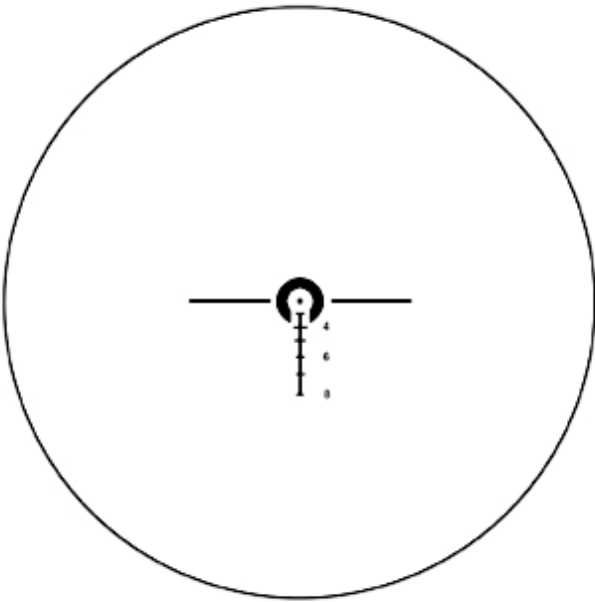

**CQB-BDC**

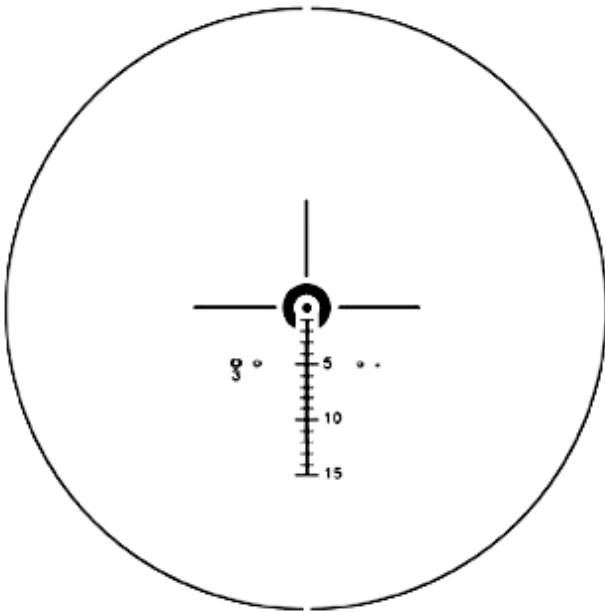

**M Series CQB**

# Zeiss Reticle Patterns

		Non-Illuminated Reticles								Reticles With Illumination										
Model	image plane	4	8	20	43	RZ 600	RZ 800	RZ 1000	RZ Varmint	0	40	43	44	56	60	66	RZ 600	RZ 800	RZ 1000	RZ Varmint
Victory Diarange with reticle in the 2nd image plane																				
Diarange 2.5–10x50 T*	2																• <sup>Δ</sup>	• <sup>Δ</sup>		
Diarange 3–12x56 T*	2																• <sup>Δ</sup>	• <sup>Δ</sup>		
Victory Varipoint with reticle in the 1st or 2nd image plane																				
Varipoint 1.1–4x24 T*	1+2									• <sup>Δ</sup>				• <sup>Δ</sup>						
Varipoint 1.5–6x42 T*	1+2									• <sup>Δ</sup>				• <sup>Δ</sup>						
Varipoint 2.5–10x42 T*	1+2									• <sup>Δ</sup>				• <sup>Δ</sup>						
Varipoint 2.5–10x50 T*	1+2									• <sup>Δ</sup>				• <sup>Δ</sup>						
Varipoint 3–12x56 T*	1+2									• <sup>Δ</sup>				• <sup>Δ</sup>						
Victory Diavari with reticle in the 1st image plane																				
Diavari 1.5–6x42 T*	1	●	●																	
Diavari 2.5–10x42 T*	1	●	●																	
Diavari 2.5–10x50 T*	1	●	●							●		●		●	●					
Diavari 3–12x56 T*	1	●	●	●						●	●	●		●	●					
Victory Diavari with reticle in the 2nd image plane																				
Diavari 6–24x56 T*	2	●			●			●	●	●	●			●					●	●
Diavari 6–24x72 T* FL	2									●	●			●					●	●
Conquest																				
1.8x5.5x38 MC	2			●																
2.5-8x32 MC	2			●																
4x32 MC	2			●																
3-9x40 MC	2	●		●		●														
3.5-10x44 MC	2	●		●	●	●	●													
4.5-14x44 MC	2	●		●	●			●	●											
3-9x50 MC	2	●		●		●														
3.5-10x50 MC	2	●		●	●	●	●													
4.5-14x50 MC	2	●		●	●			●	●											
6.5-20x50 MC	2	●		●	●			●	●											
3-12x56 MC	1		●																	

RETICLES BY MODEL

T\* = Carl Zeiss T\* multi-coating, FL = Fluoride Glass.

Δ Illuminated Reticles for Daytime and Twilight.

# Zeiss Reticle Patterns

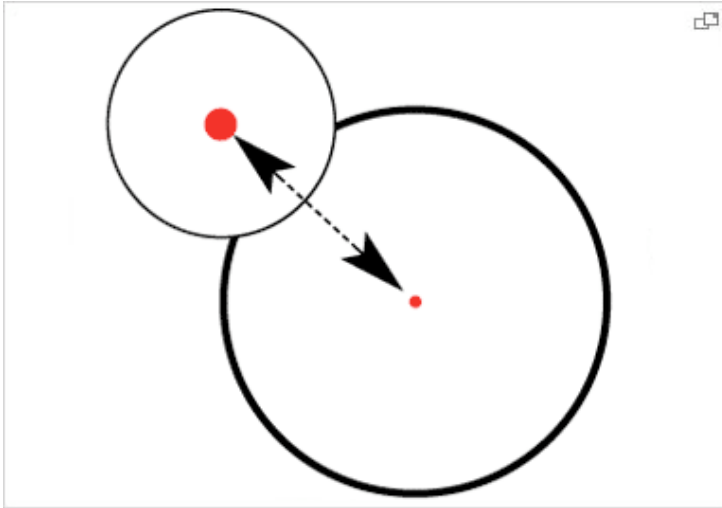

**Reticle 0**

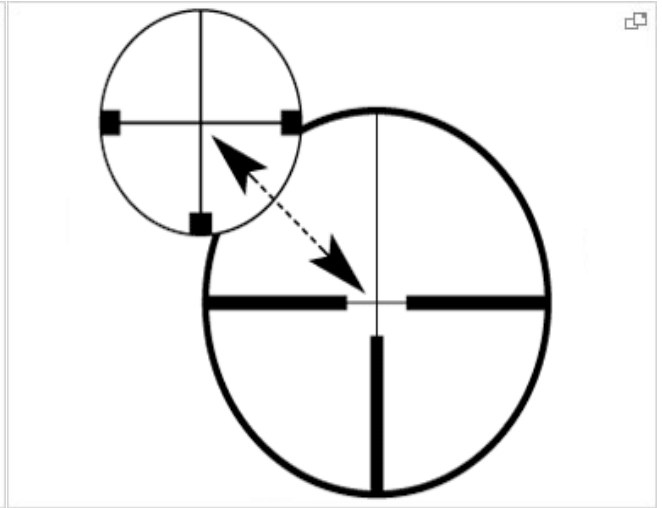

**Reticle 4**

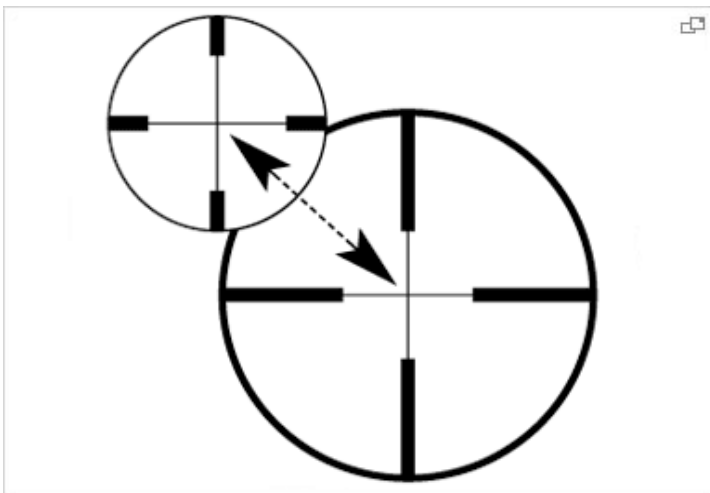

**Reticle 8**

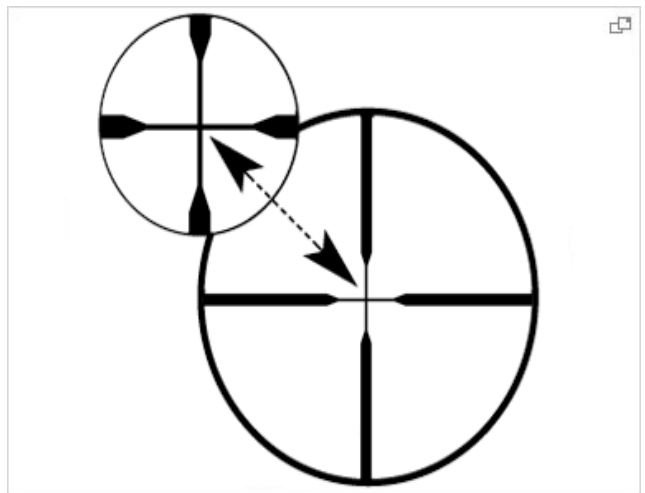

**Reticle 20 Z-Plex**

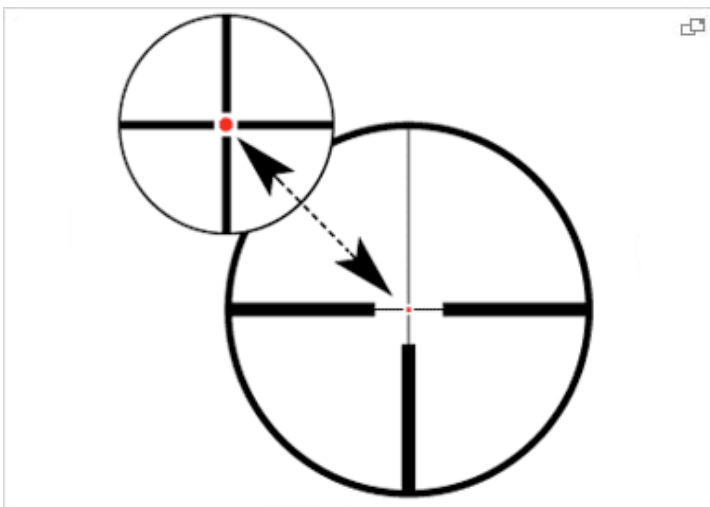

**Reticle 40**

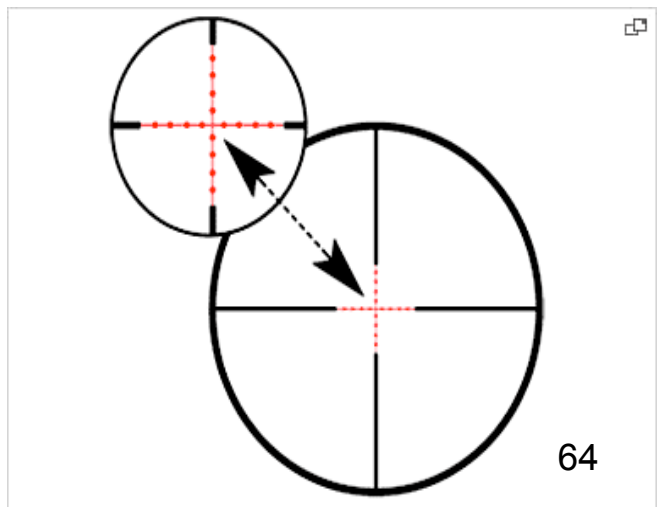

**Reticle 43**



# Zeiss Reticle Patterns

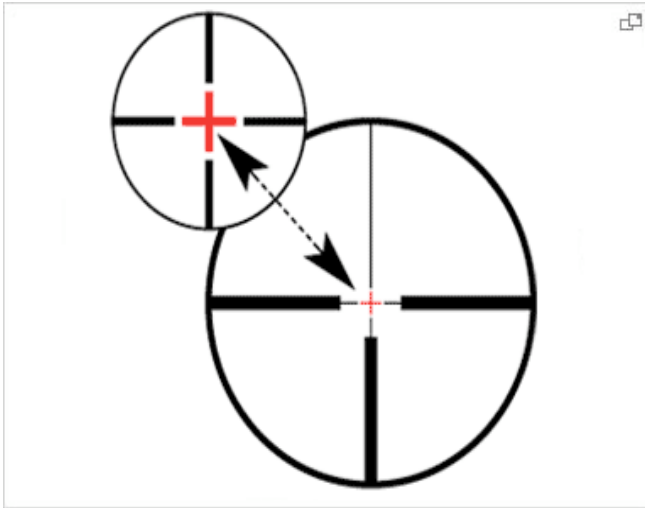

**Reticle 44**

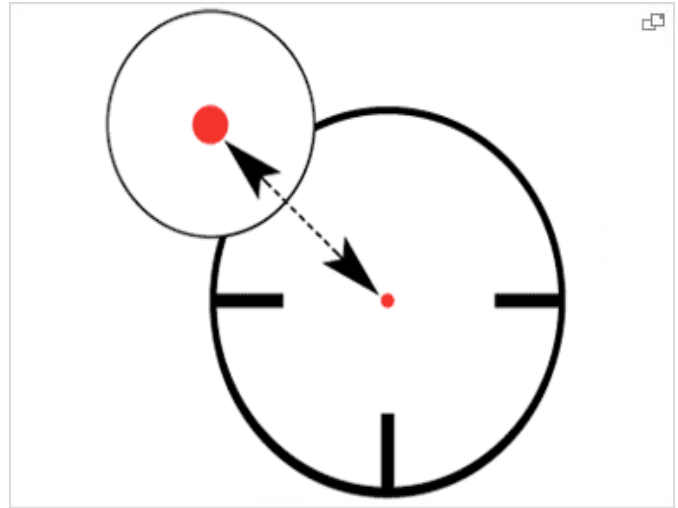

**Reticle 56**

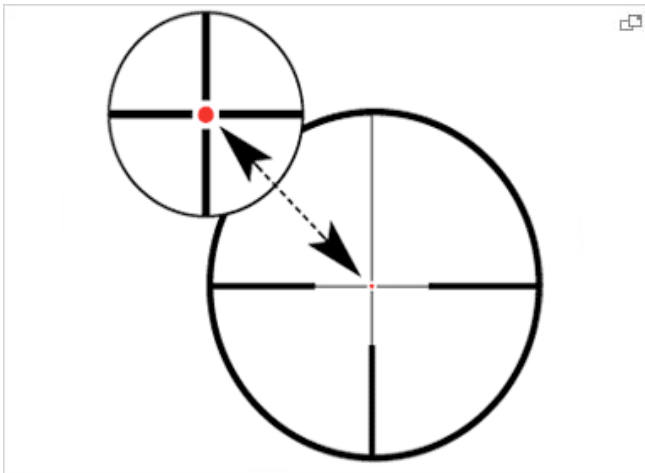

**Reticle 60**

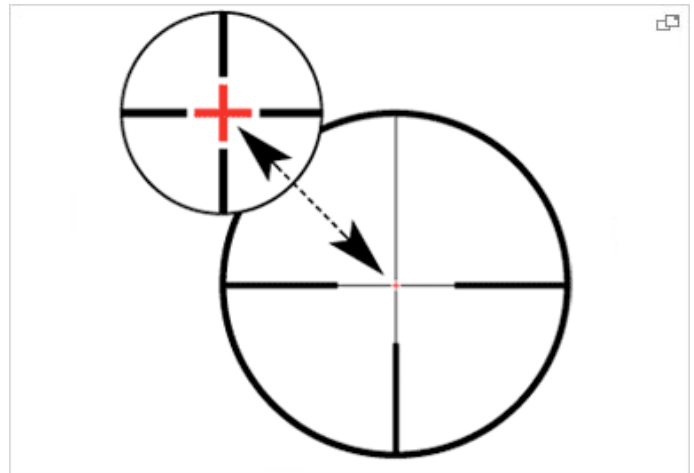

**Reticle 66**

# Zeiss Rapid-Z Reticule Patterns

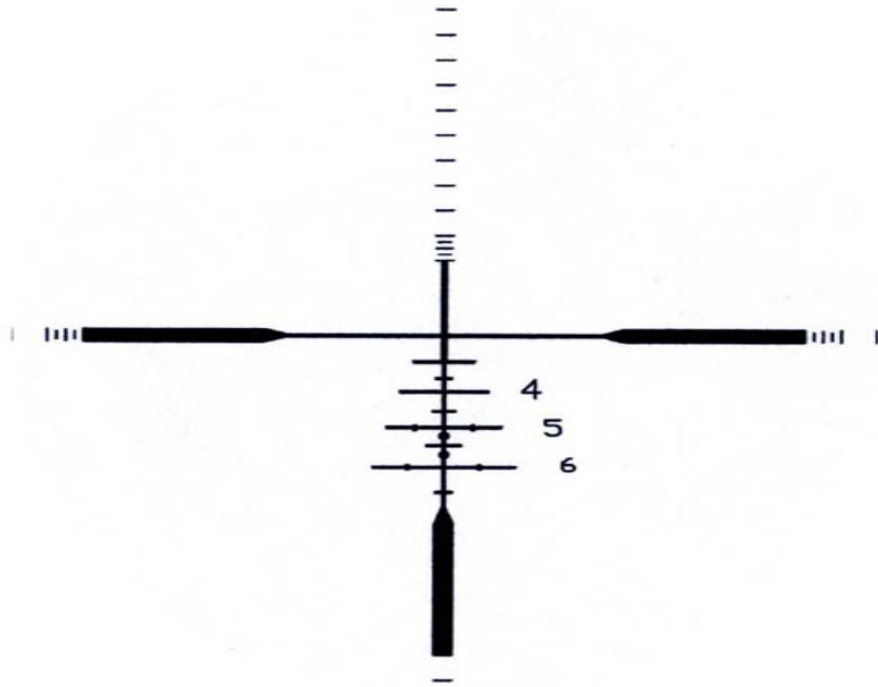

**RAPID - Z<sup>®</sup> 600**

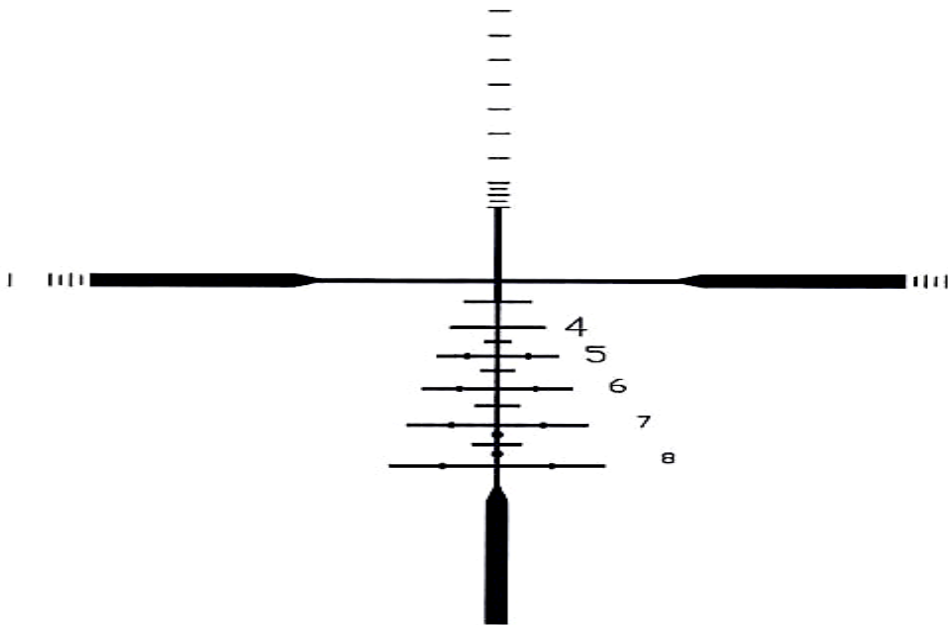

**RAPID - Z<sup>®</sup> 800**

# Zeiss Rapid-Z Reticle Patterns

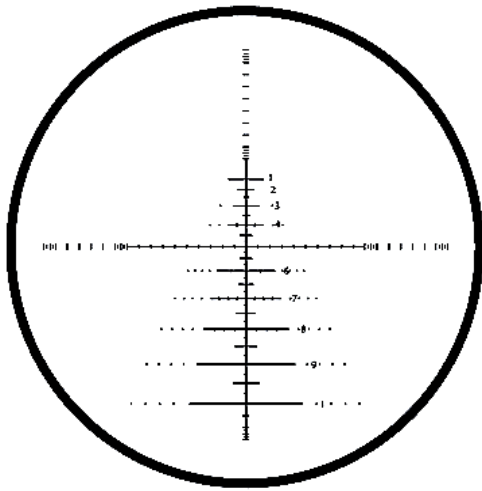

**RAPID - Z ® 1000**

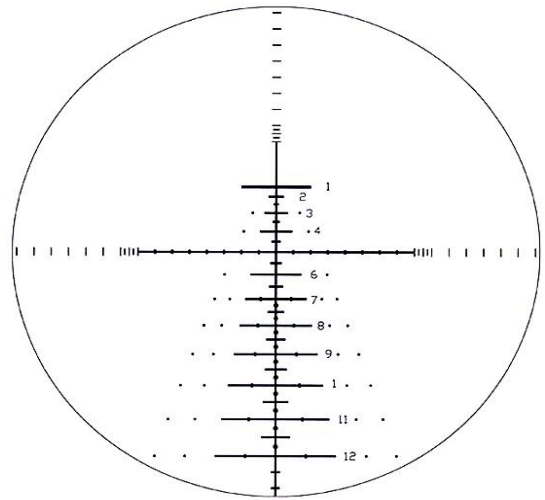

**RAPID - Z ® 1200**

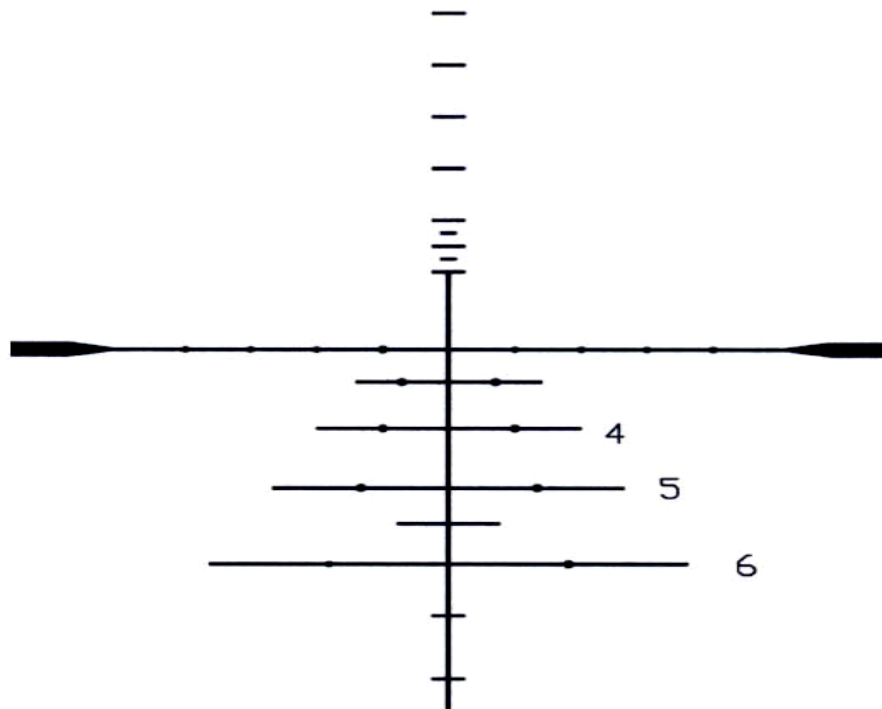

**RAPID - Z ® VARMINTER**

# Hensoldt Reticle Patterns

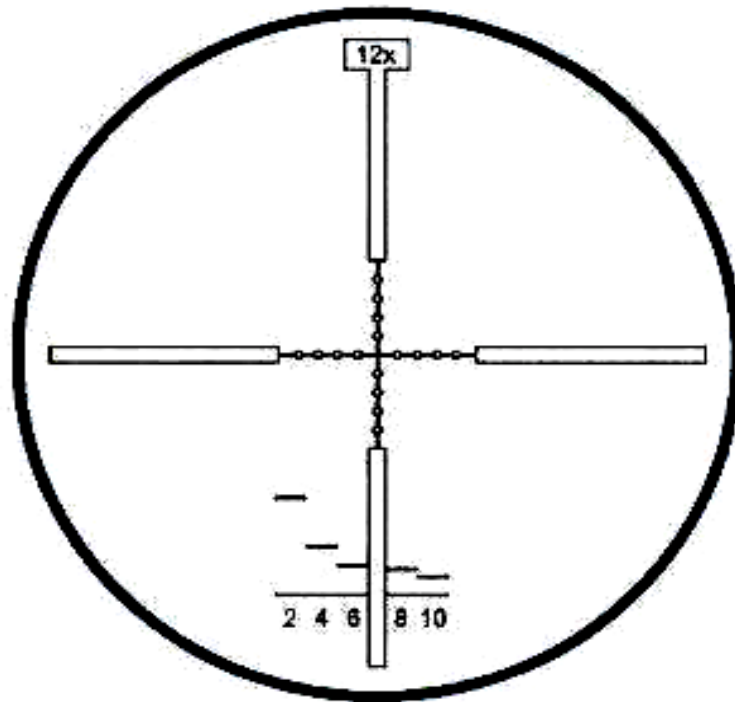

## Hensoldt Range Finding Mil Dot

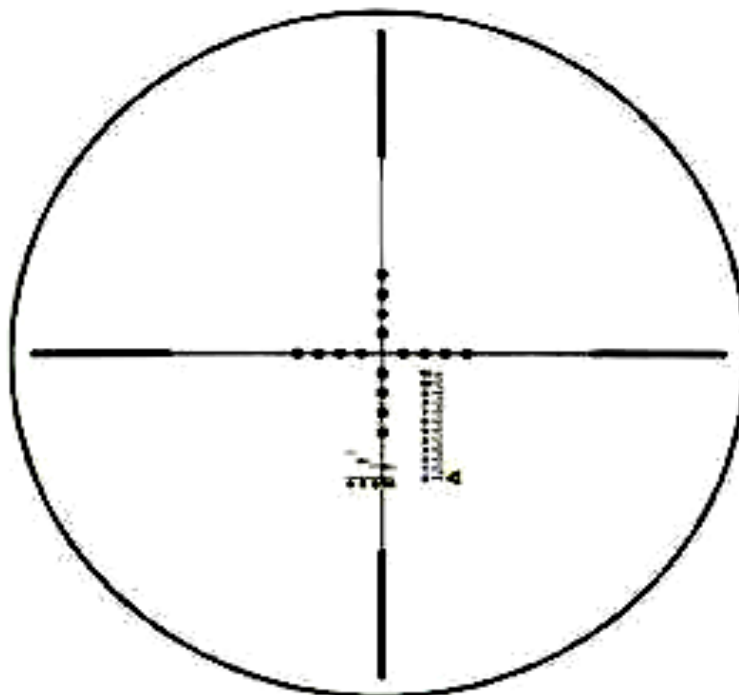

## Hensoldt SSG - P

# Leupold Reticle Patterns



**Standard Duplex**



**Fine Duplex**



**Illuminated Duplex**



**CPC**



**Leupold Dot**

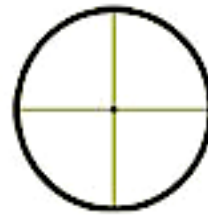

**Target Dot**

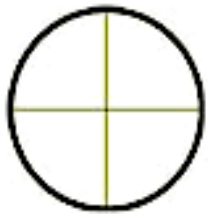

**Crosshair**

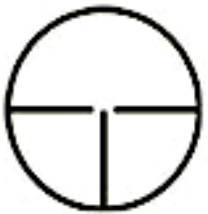

**German #1**

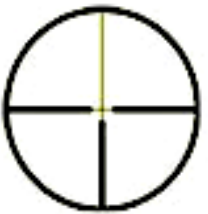

**German #4**

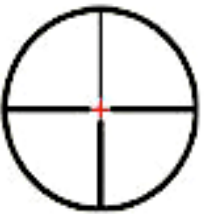

**Illuminated German #4**

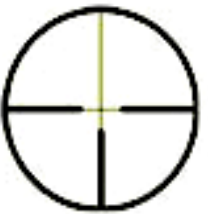

**Post & Duplex**

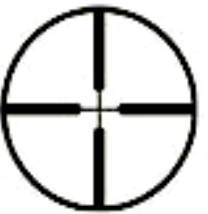

**Heavy Duplex**

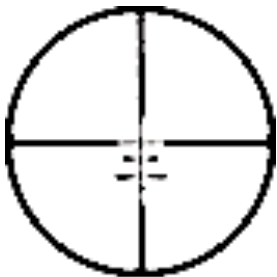

*Boone & Crockett*

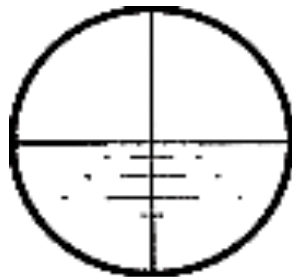

*Varmint Hunter's*

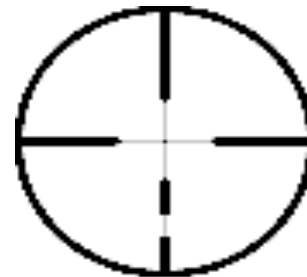

*Wide Duplex RE*

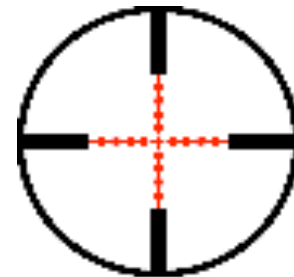

*Illuminated Mil Dot*

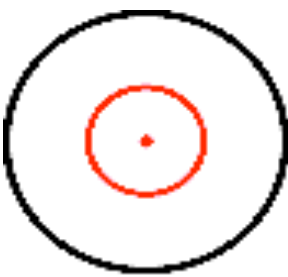

*VX-III Illuminated Circle Dot (when illuminated)*

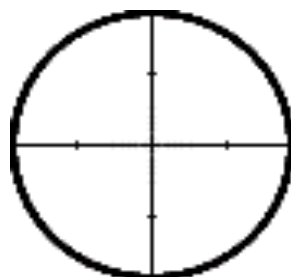

*Tactical Milling*

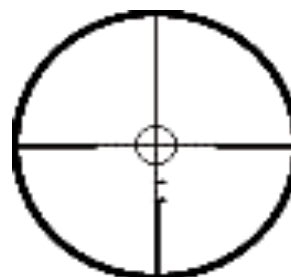

*Special Purpose*

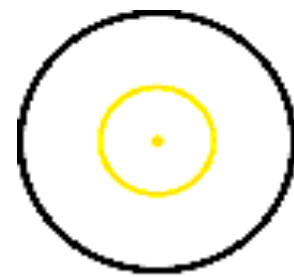

*CQ/T Illuminated Circle Dot (when illuminated)*

# Leupold Reticle Pattern Tactical Milling Reticle

## TACTICAL MILLING RETICLE MEASUREMENTS

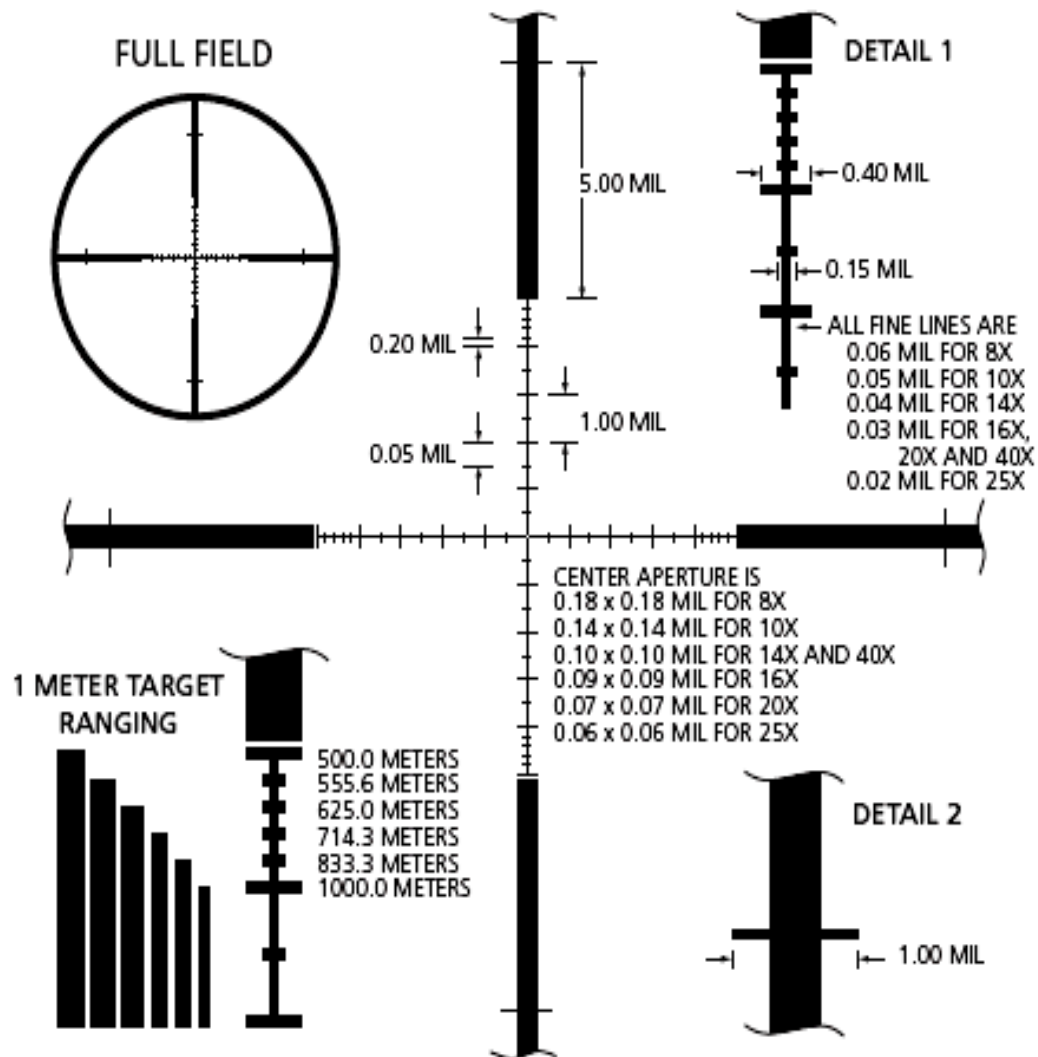

@100 Meters	5.0 mil = 18.000"	0.20 mil = 0.720"
	1.0 mil = 3.600"	0.15 mil = 0.54"
	0.5 mil = 1.800"	0.10 mil = 0.360"
	0.4 mil = 1.400"	1.0 mil = 3.438 Minutes of Angle = 3.600"

# Leupold Reticle Patterns (Detail – Boone & Crockett Reticle)

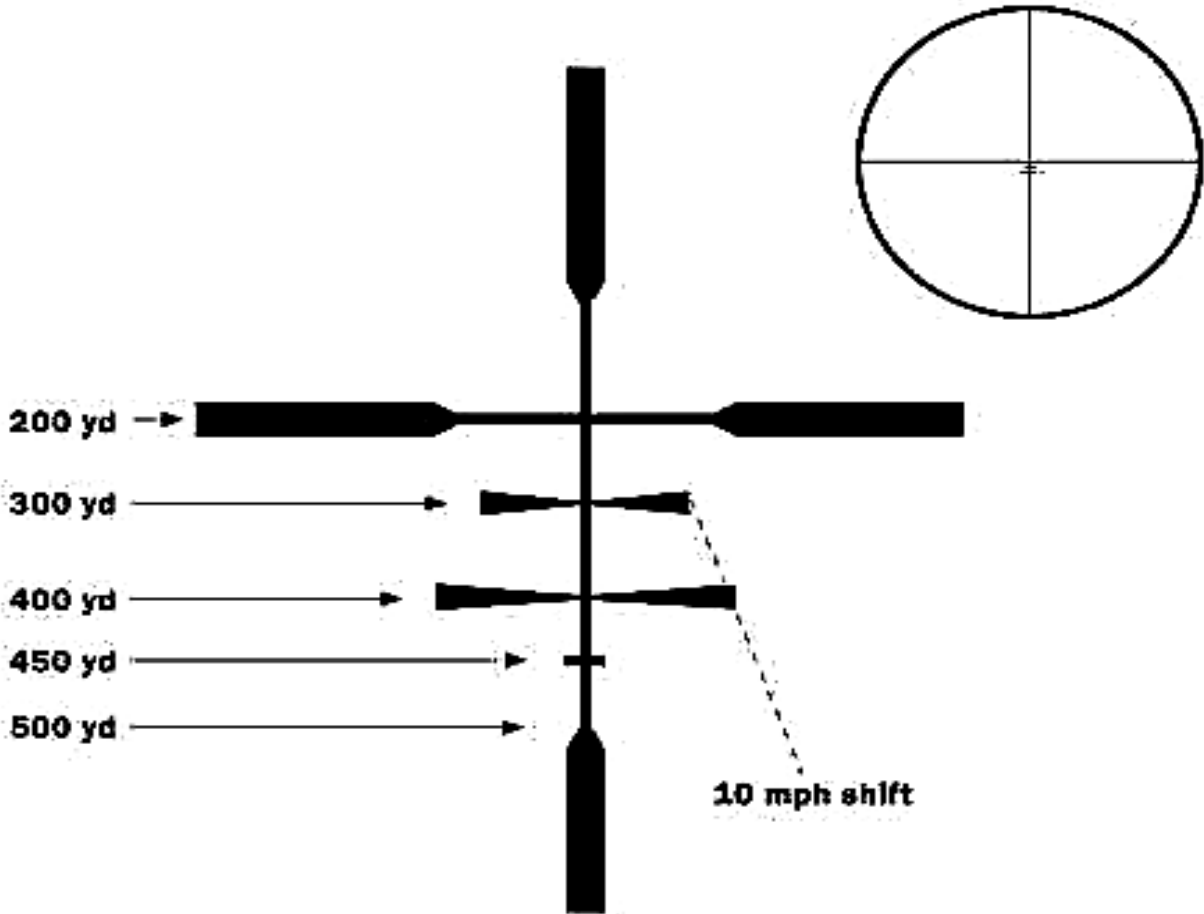

RANGE	POWER SELECTOR VALUES		10 MPH DRIFT
	LARGE ▼ BULLET DROP	SMALL ▼ BULLET DROP	
200 yd MOA	0.00	0.00	—
200 yd Inches	0.00	0.00	—
300 yd MOA	2.19	2.74	2.16
300 yd Inches	6.88	8.61	6.79
400 yd MOA	4.80	6.00	3.03
400 yd Inches	20.11	25.13	12.69
450 yd MOA	6.26	7.83	—
450 yd Inches	29.50	36.87	0.00
500 yd MOA	7.82	9.775	—
500 yd Inches	40.95	51.18	0.00

# Leupold Reticle Patterns

## Tactical Special Purpose Reticle (SPR)

### Holdover Diagram

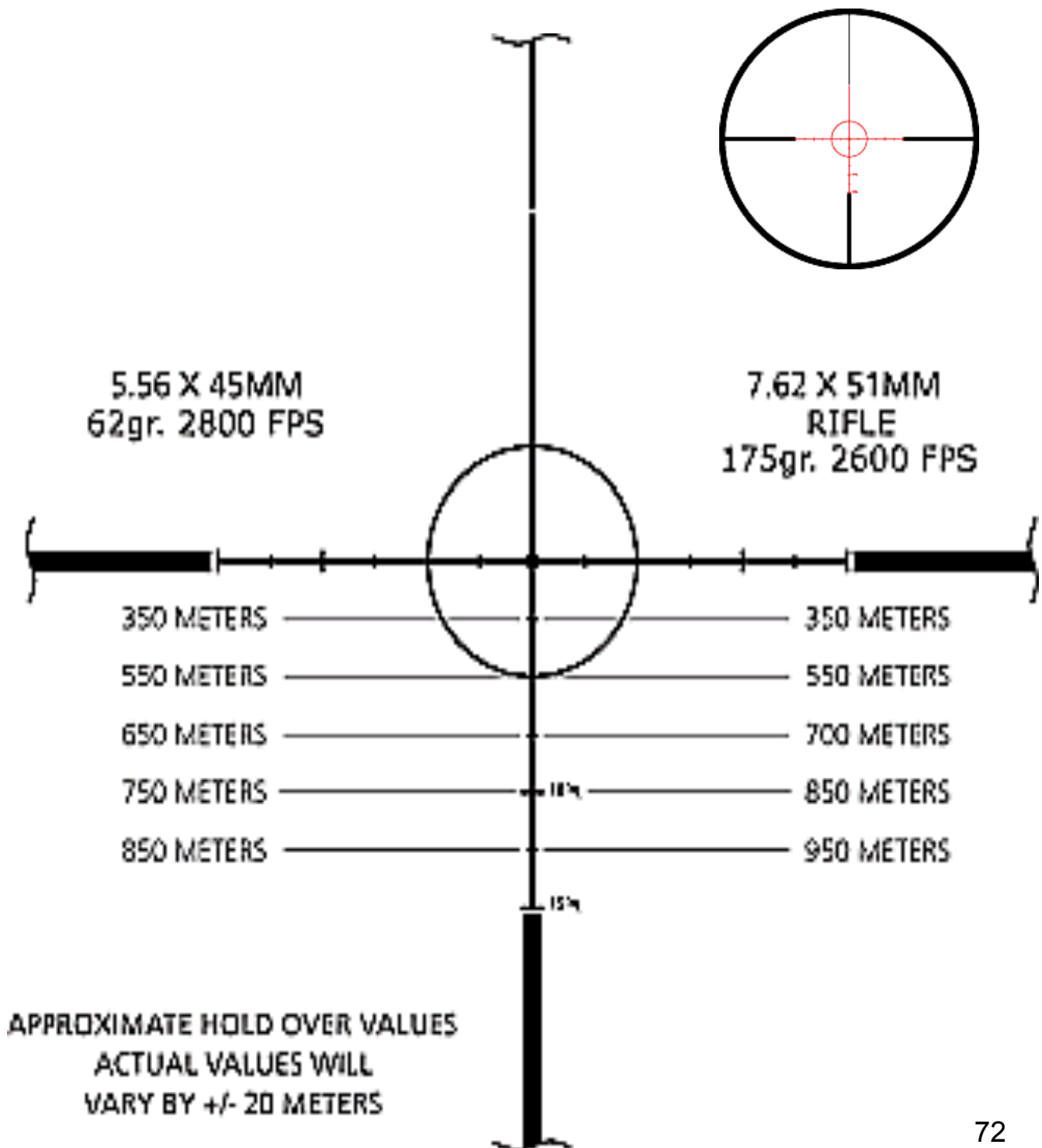



# Leupold Reticle Patterns

## Tactical Special Purpose Reticle (SPR)

### Subtensions Diagram

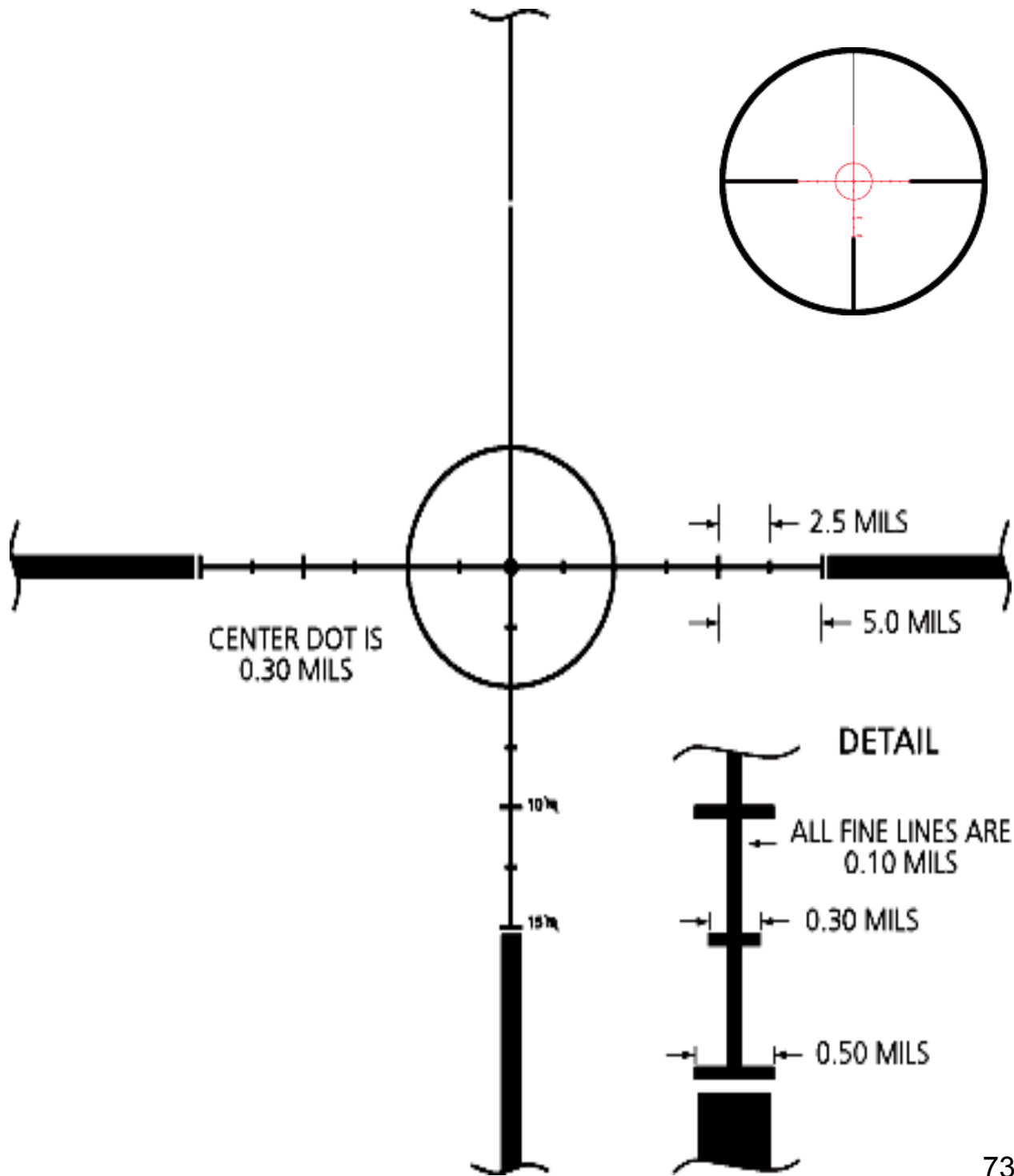

# Leupold Reticle Patterns

## Tactical Special Purpose Reticle (SPR)

### Range Estimating Methods

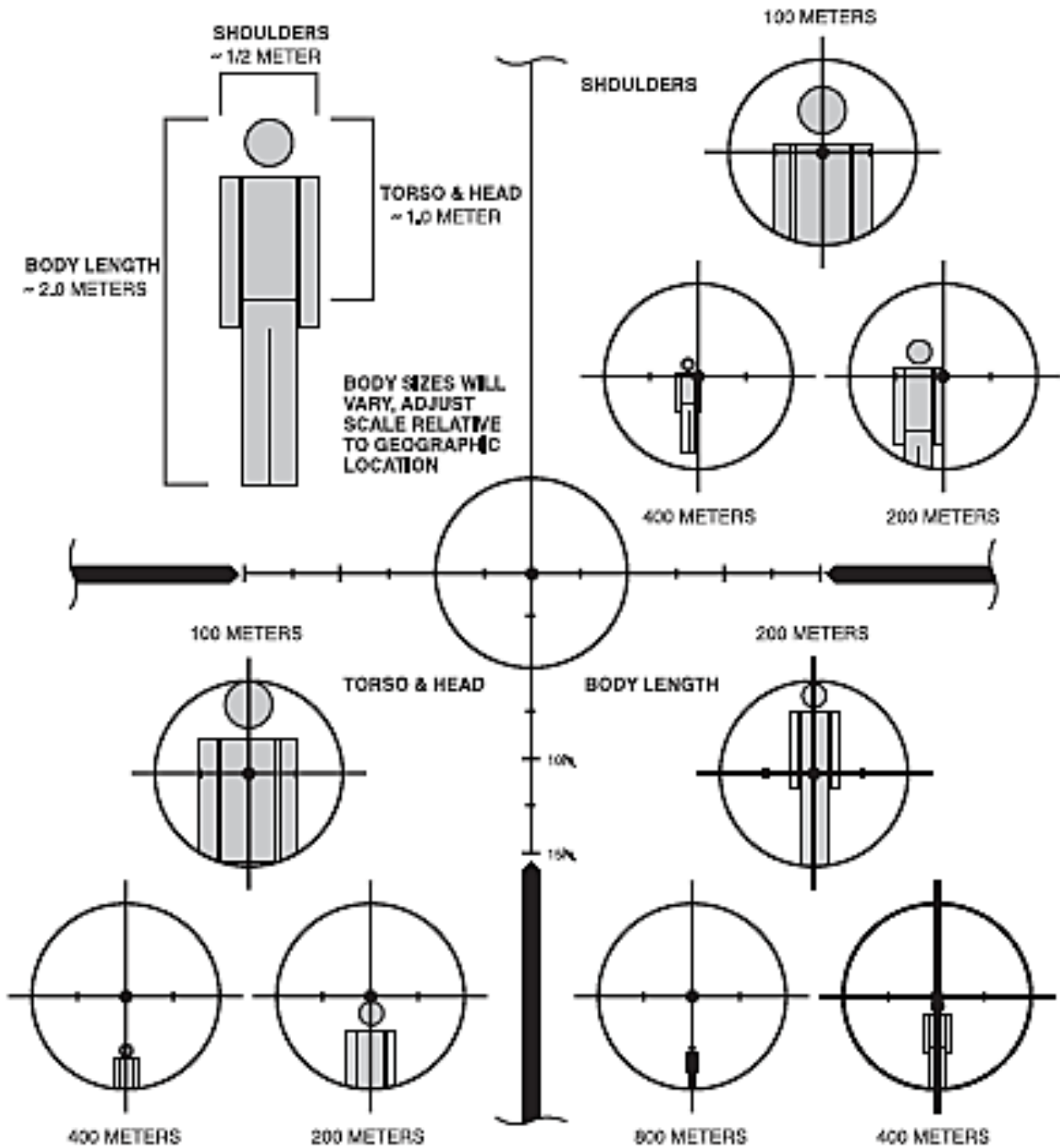

# ART 21 MOA Reticle

Ranges in MOA or MILS

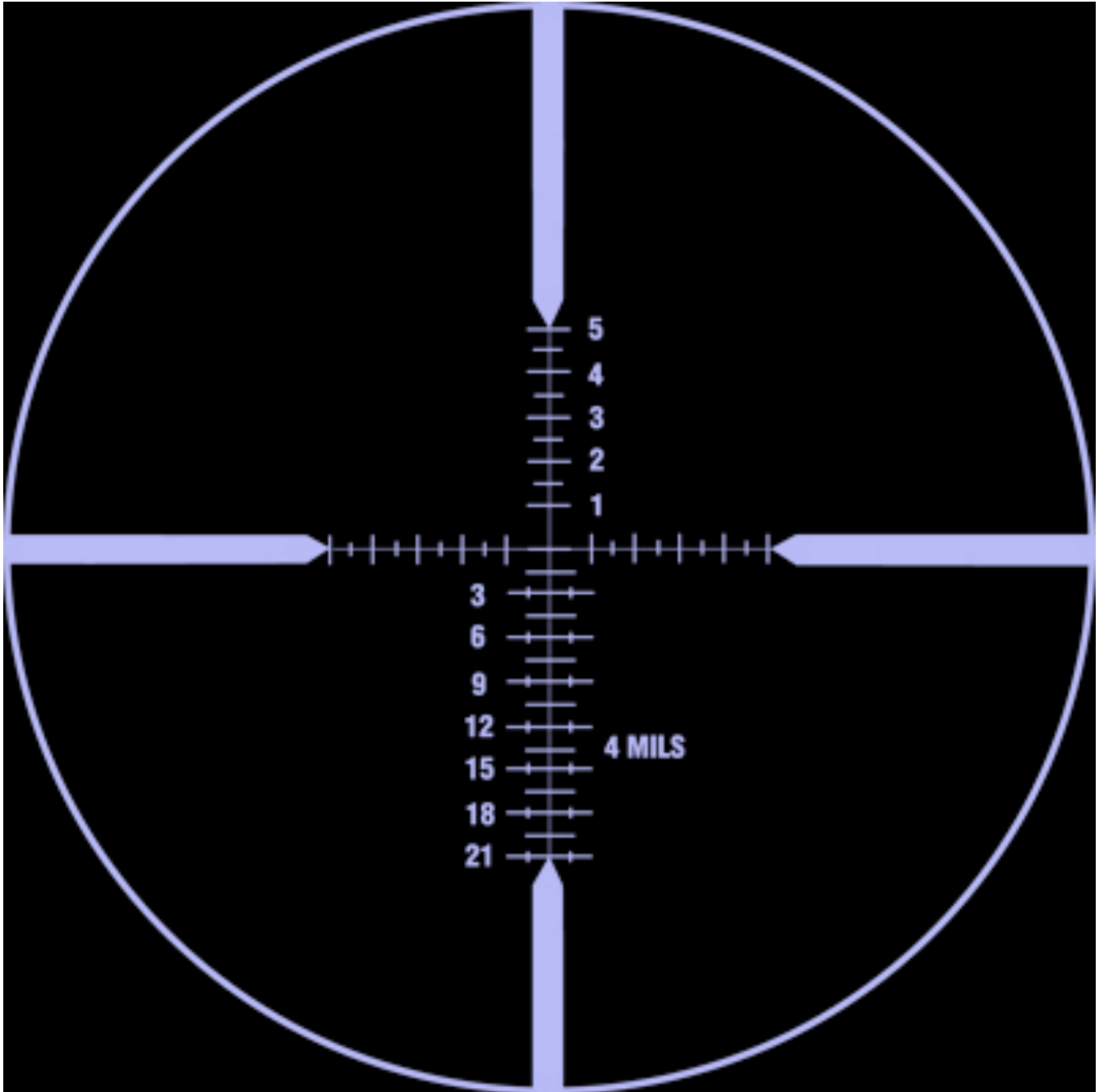

# ART 24 MOA Reticle

Ranges in MOA or MILS

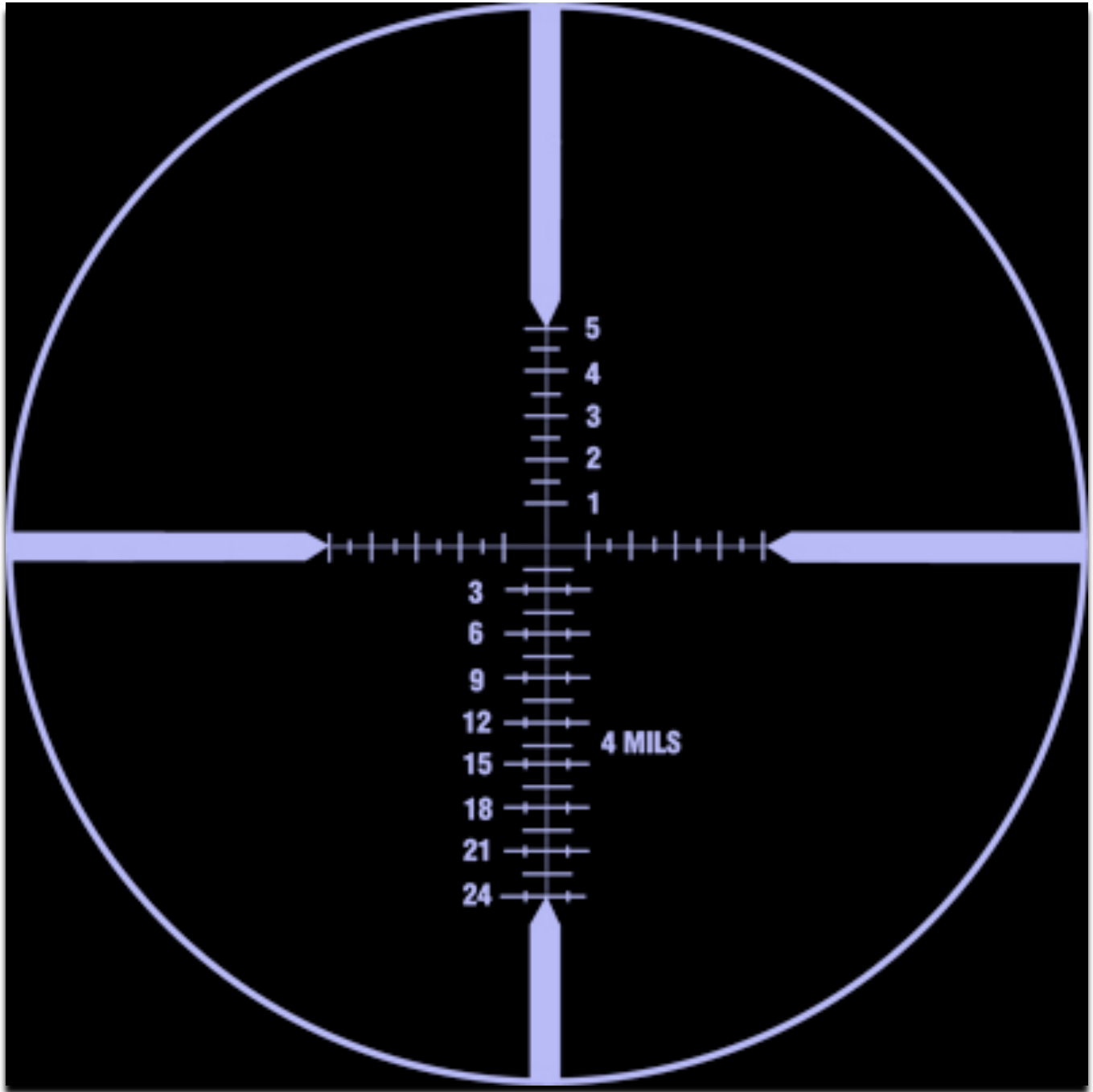

# ART 24 MOA Bar-Dot Reticle

Ranges in MOA or MILS

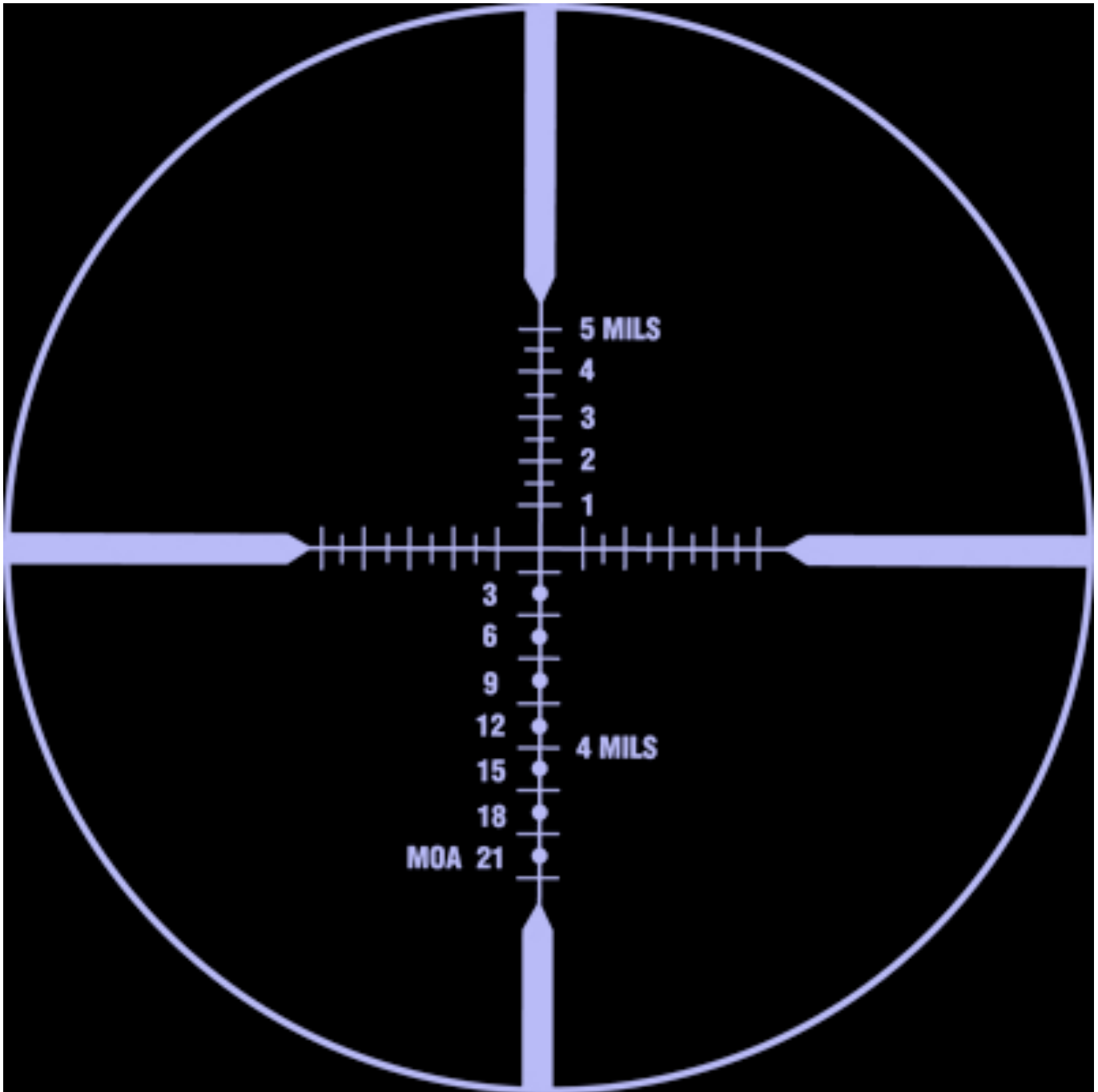

# ART 30 MOA Reticle

Ranges in MOA or MILS

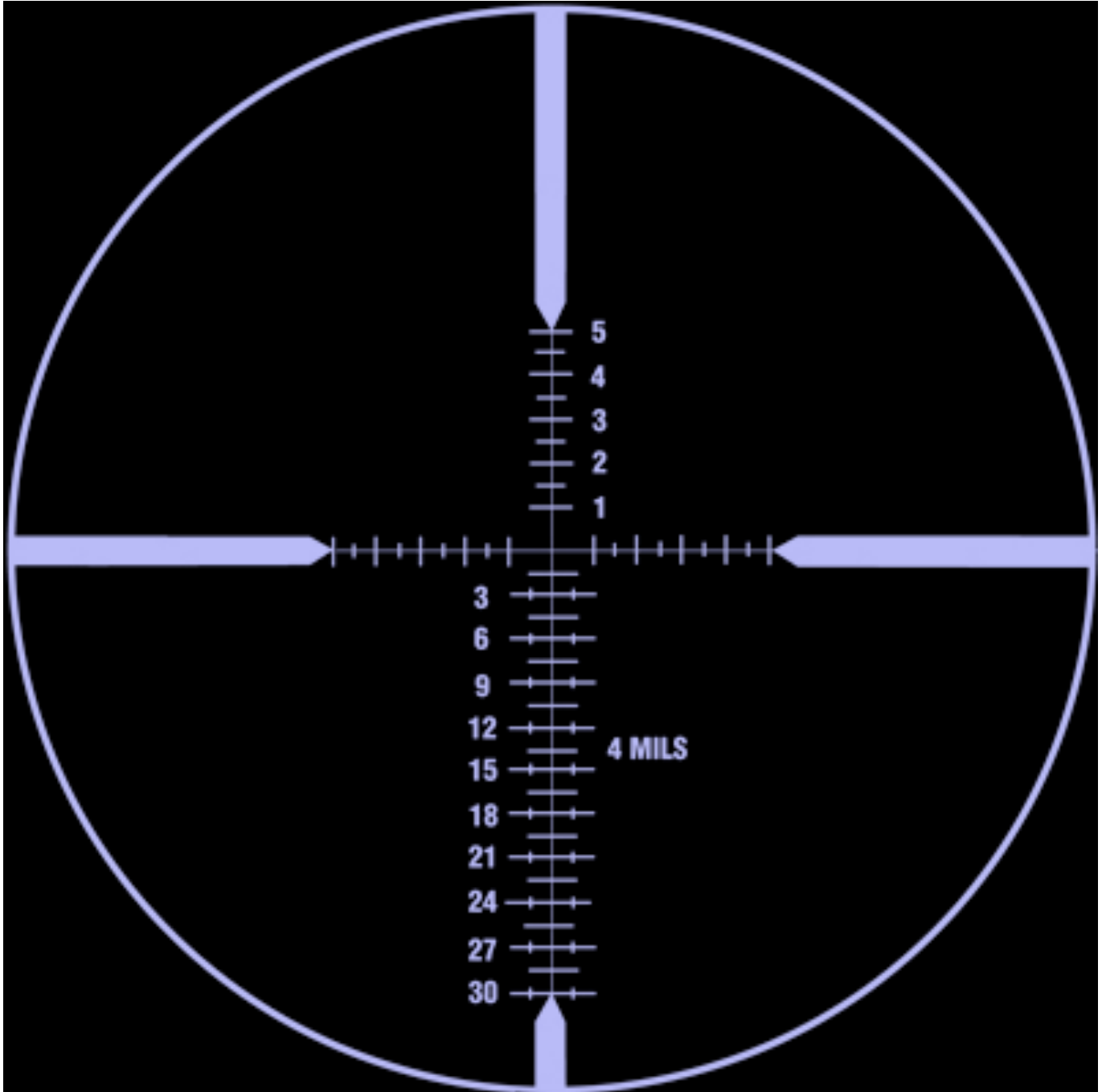

# ART ULTIMATE MIL Reticle

## Ranges in MILS



# Super Sniper CQB Tactical Reticles

1x



4x



1x



4x

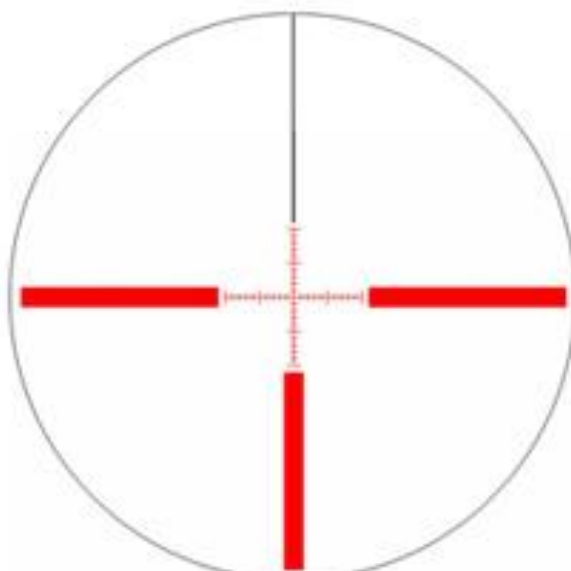



# Super Sniper Long Range Tactical Reticle

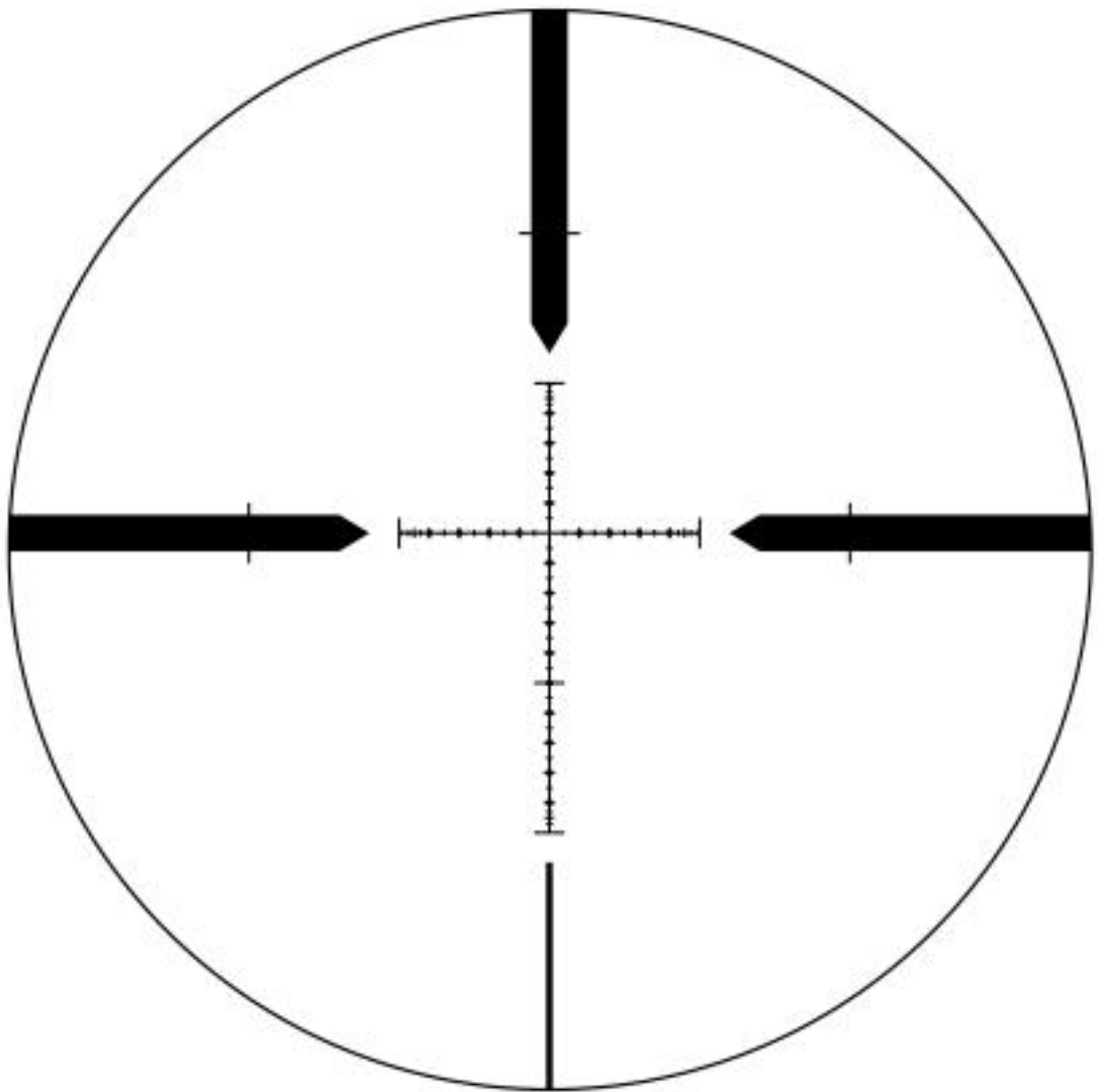

# Swarovski Reticle Patterns

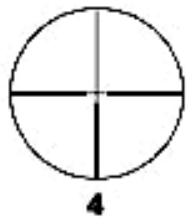

**4**

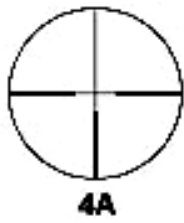

**4A**

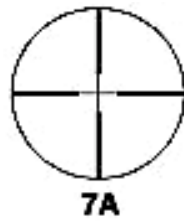

**7A**

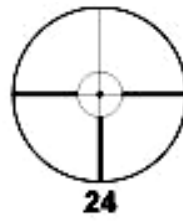

**24**



**PLEX**



**TDS Plex**

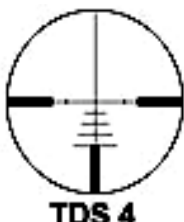

**TDS 4**

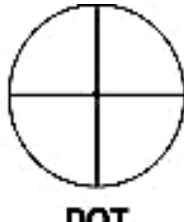

**DOT**

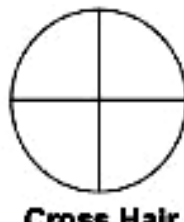

**Cross Hair**



**Plex N (IR)**



**4N**



**4NK**



**HG Circle Dot**

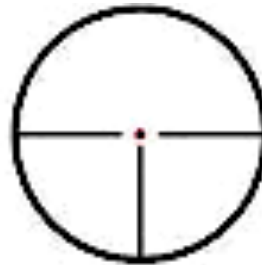

**HG Dot**

# Bushnell Reticle Patterns

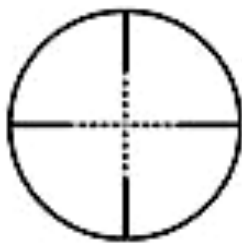

**Holo Sight**

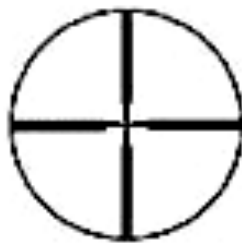

**3-2-1 Low  
Light Reticle**



**Circle X**

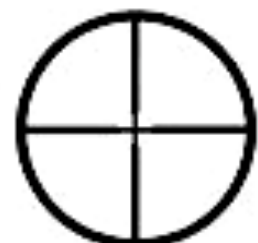

**Multit X**

# Kahles Reticle Patterns

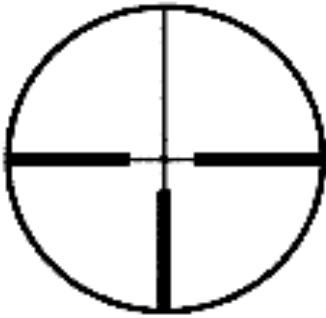

**4A**

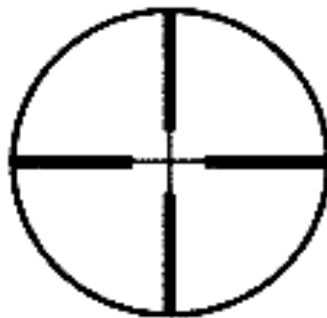

**7A**

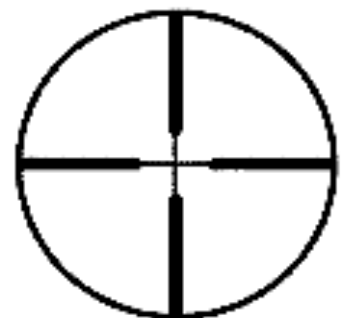

**Plex**

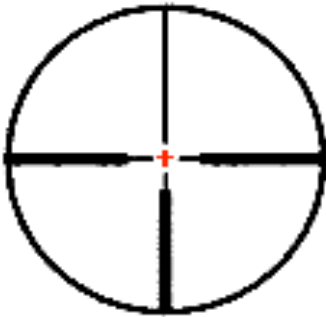

**Illuminated Reticle 4NK**

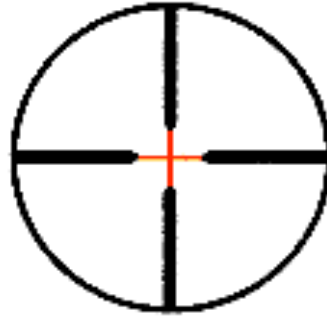

**Illuminated Reticle PlexN**

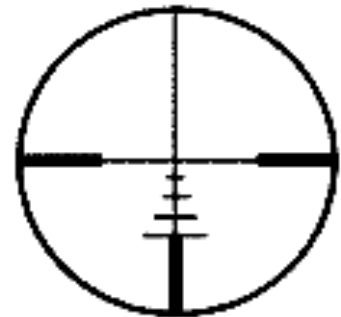

**TD Smith Reticle**



**C-Dot**

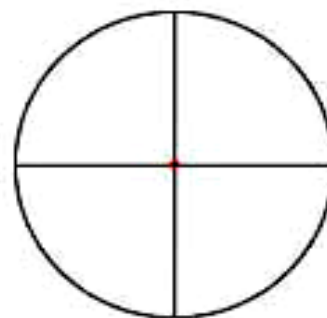

**D-Dot**



**P-Dot**

**CSX  
Illuminated  
Reticles**

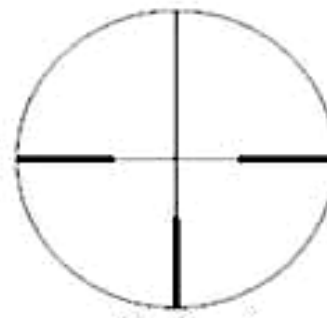

**4-Dot**

# Nikon Reticle Patterns

*Nikoplex (Duplex)*

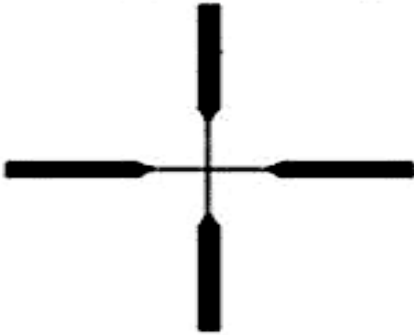

*Fine Crosshair*

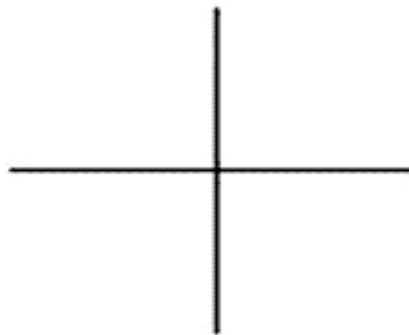

*Target Dot*

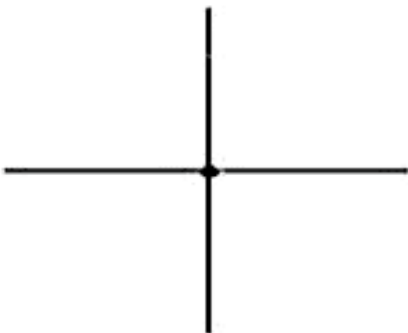

*German #4*

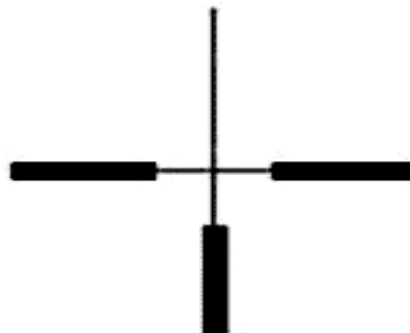

*Mildot*

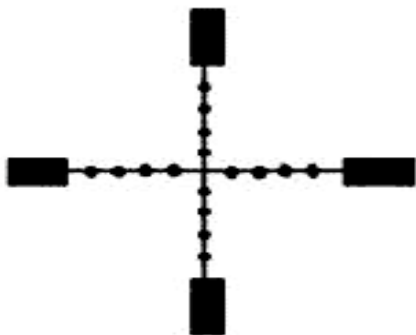

*Turkey Pro*

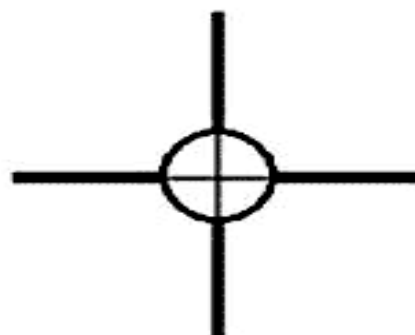

# Misc. Reticle Patterns

## S&B P4

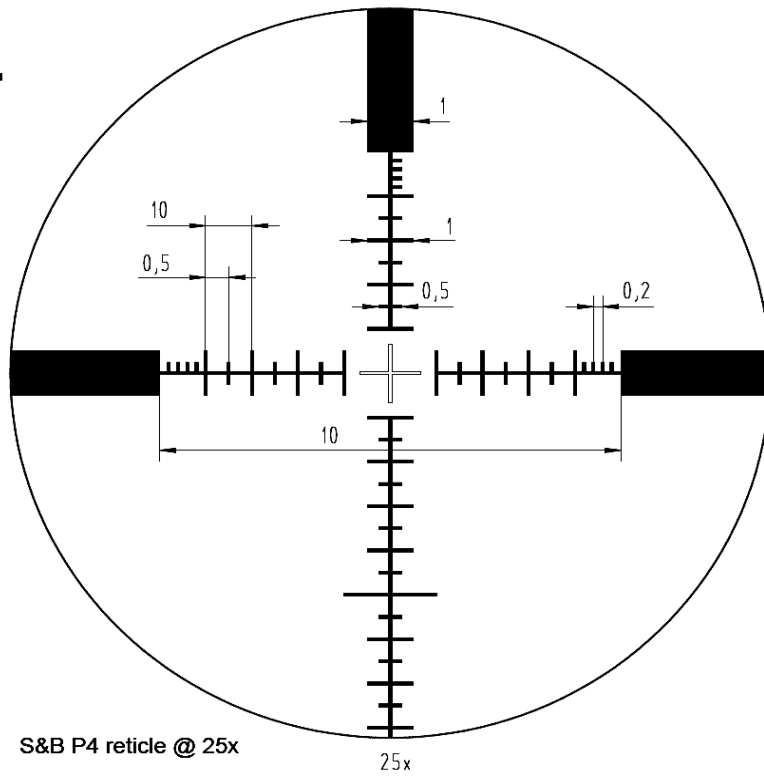

## I.O.R. MP-8

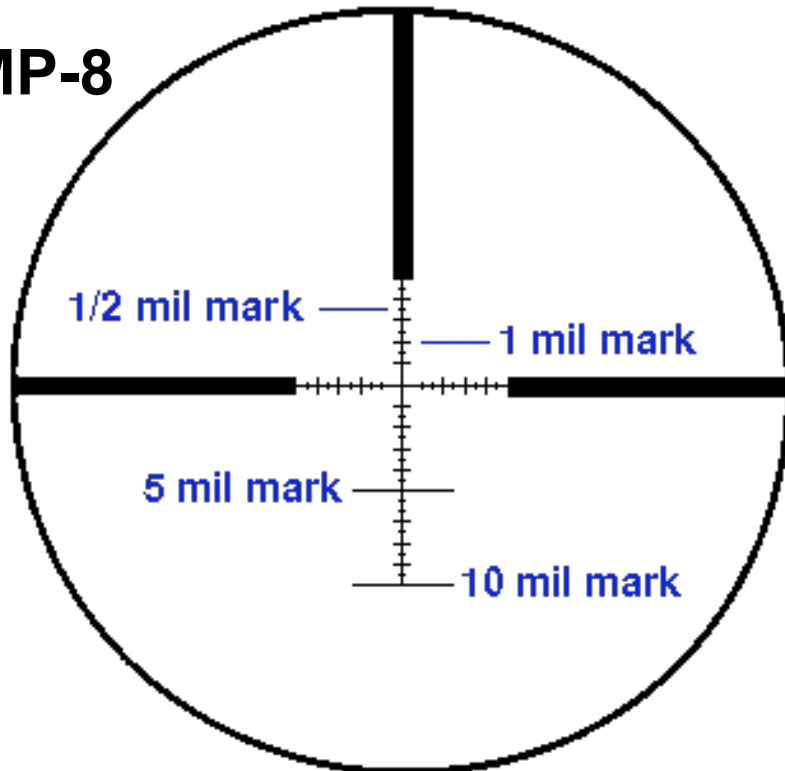

# Misc. Reticle Patterns

## AI Mil Dot

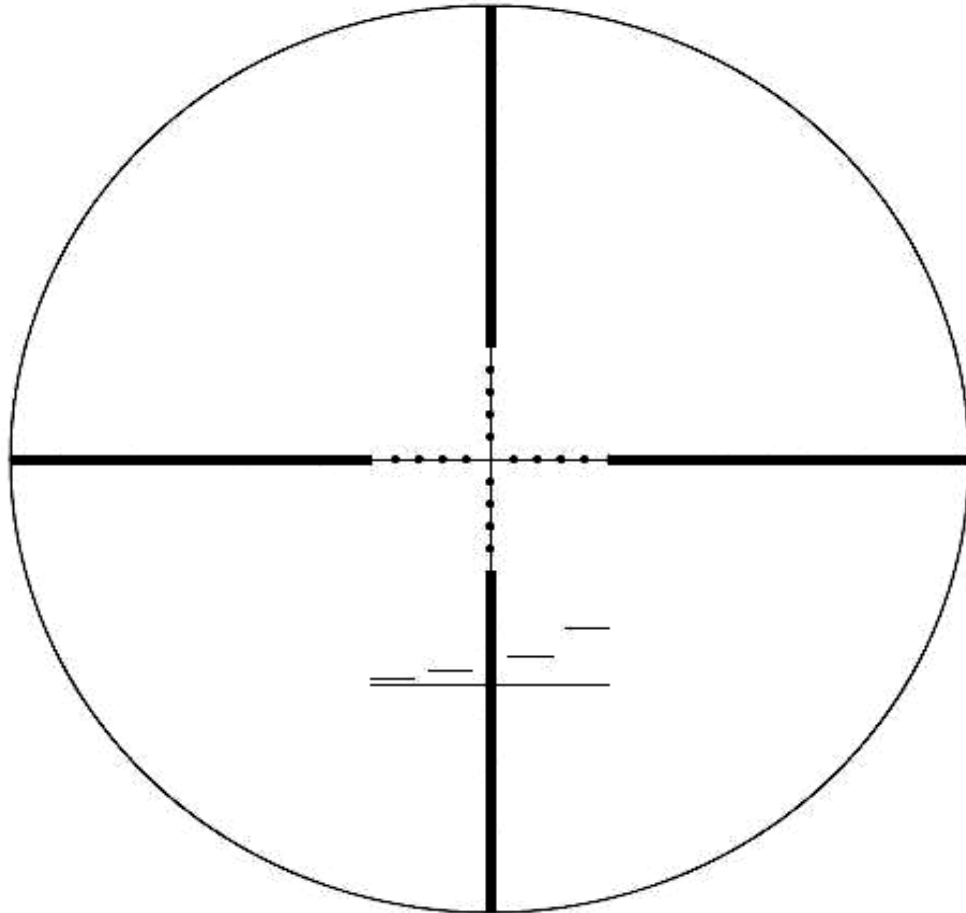

ACCURACY INTERNATIONAL MilDot

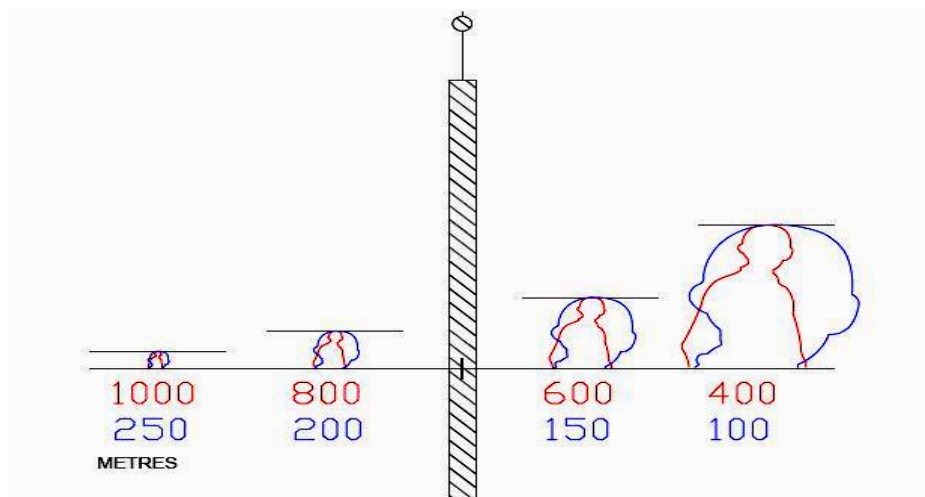

# Misc. Reticle Patterns

## Meopta Meostar R1 Scope Reticle

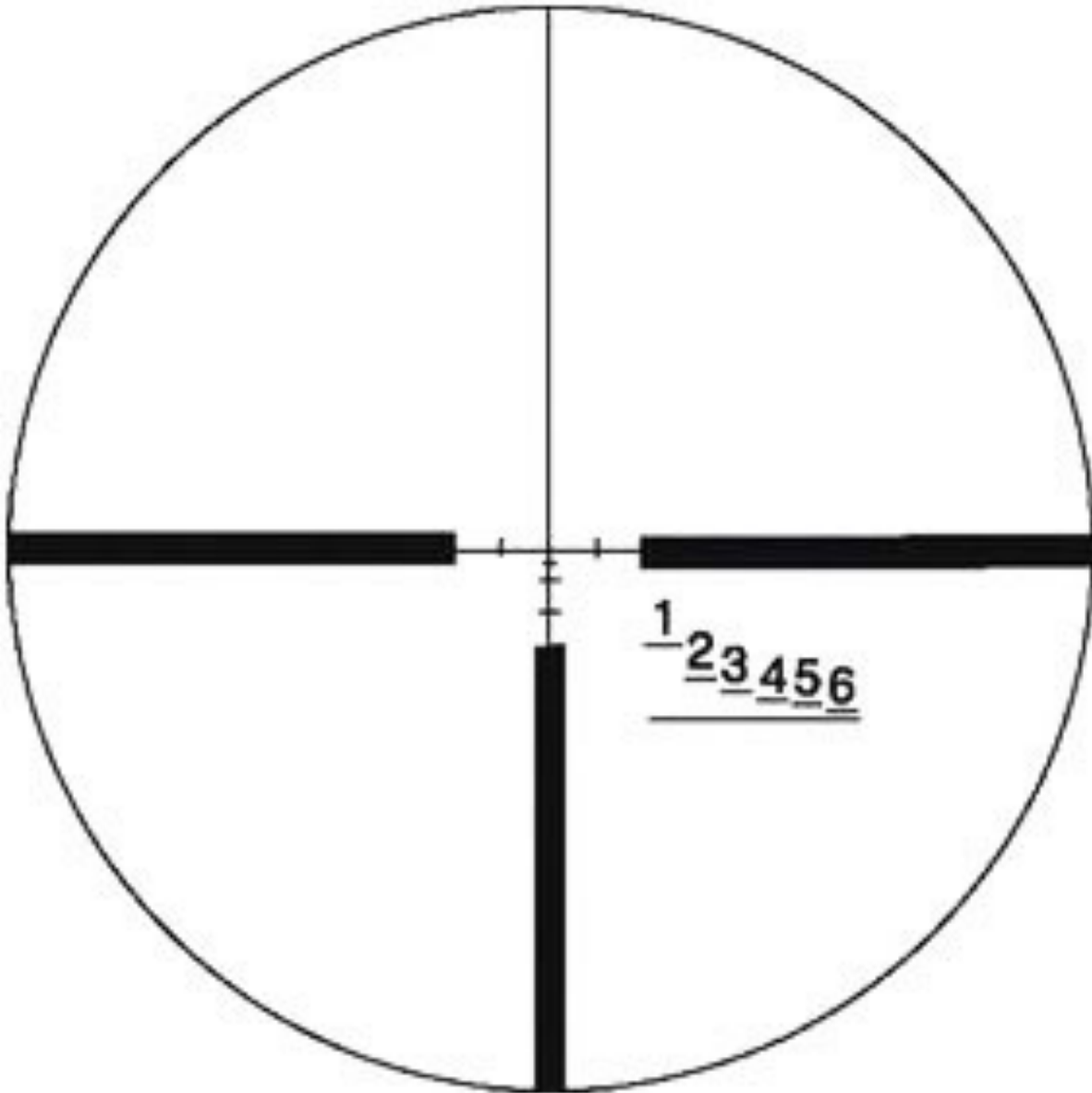

# Misc. Reticle Patterns

## Brugger & Thomet TRS

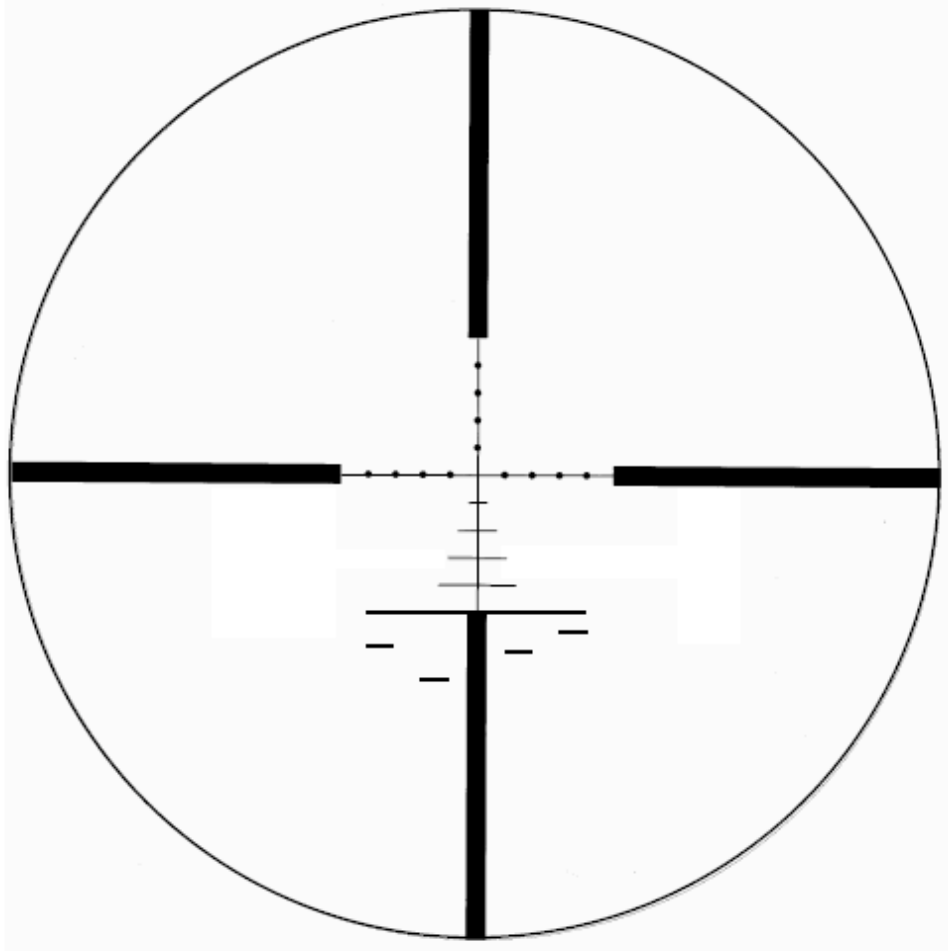

**B&T TRS Reticle Pattern.**  
**Distance dot to dot = 100 mm/100m.**

**Range estimation scale for 1 m reference height at 800 m, 400 m, 600 m and 1200 m (from left to right).**



# Misc. Reticle Patterns (Pride/Fowler Rapid Reticle)

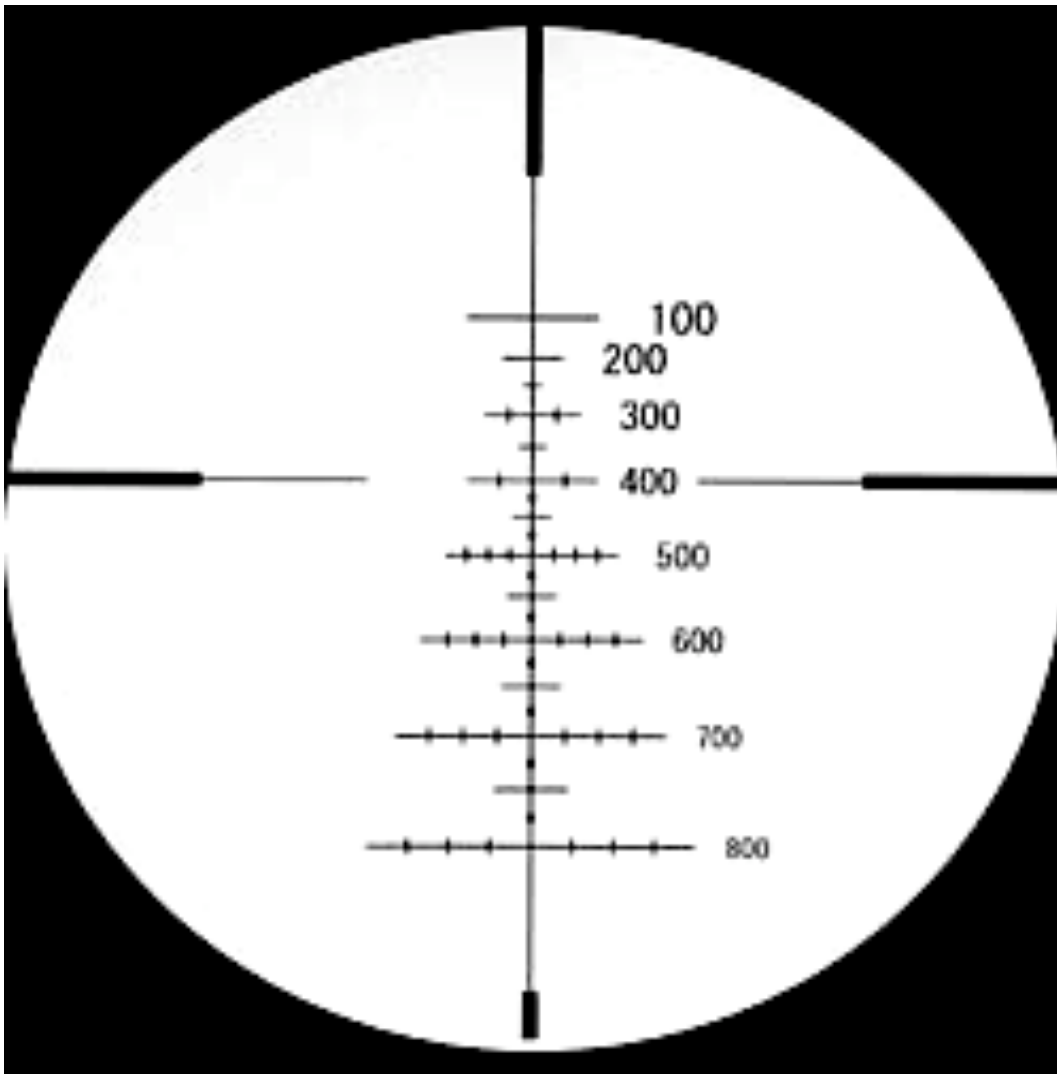

# Misc. Reticle Patterns (Firefield Russian POSP Reticle)

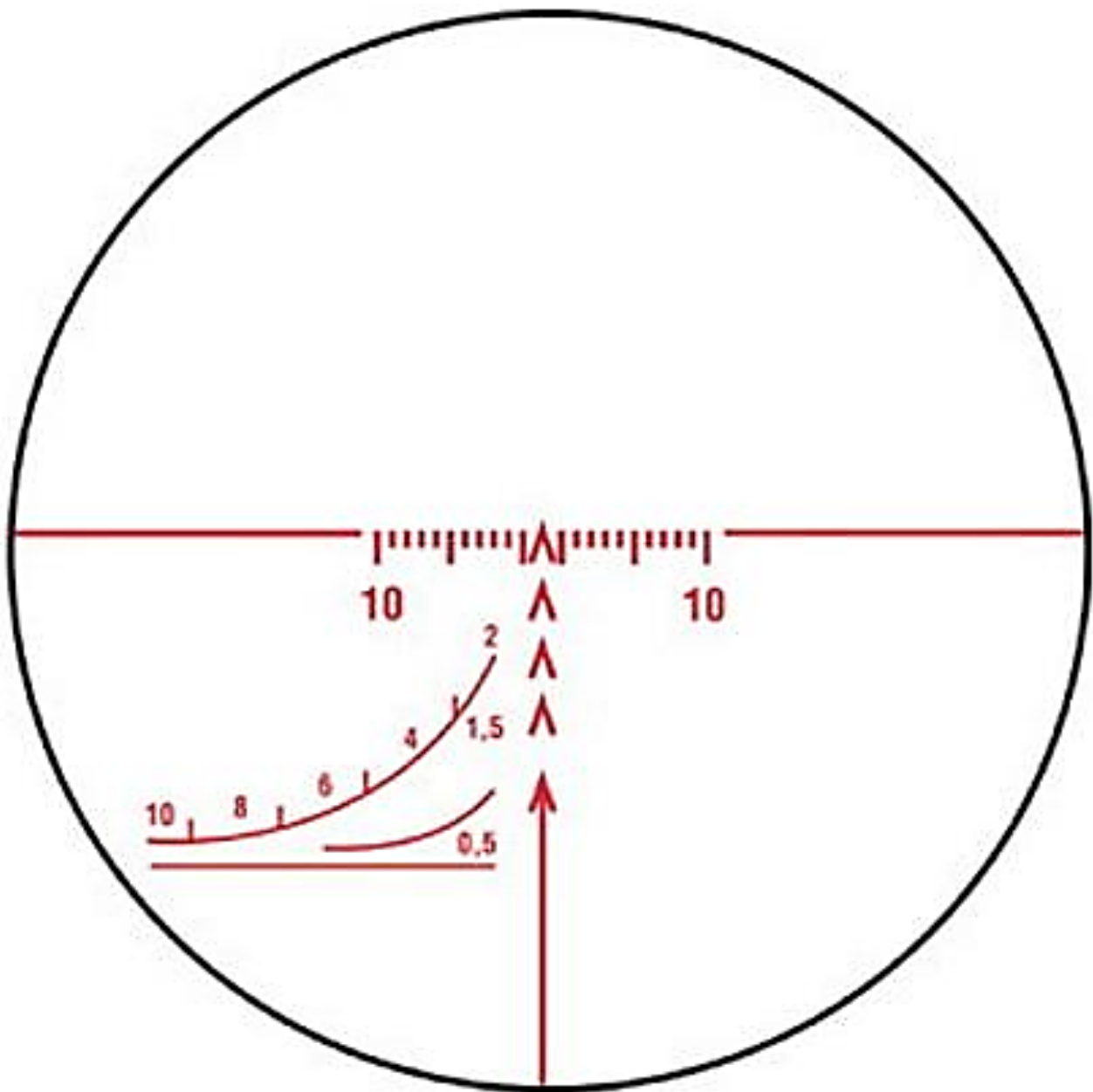

## Misc. Reticle Patterns (Huskemaw Long Range Reticle)

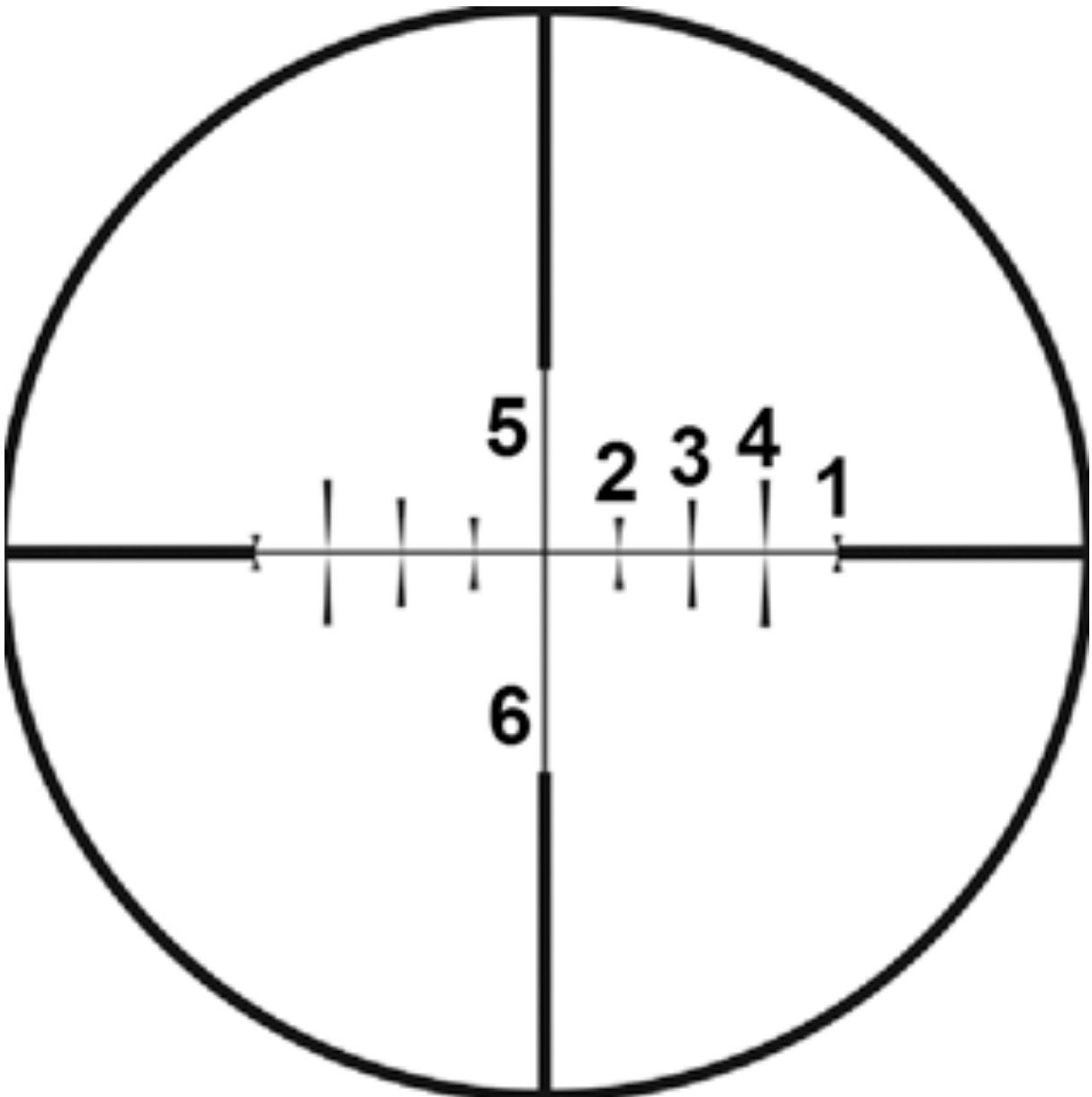

**Hunt Smart Reticle. MOA subtensions for 10X magnification. Halve values for 20X.**

# Misc. Reticle Patterns (HK G36 Style & Optisan Momba .223 BDC)

## HK G36

Lead mark for firing at targets moving from left to right at a speed of approximately 15km/h at a range of 200 meters

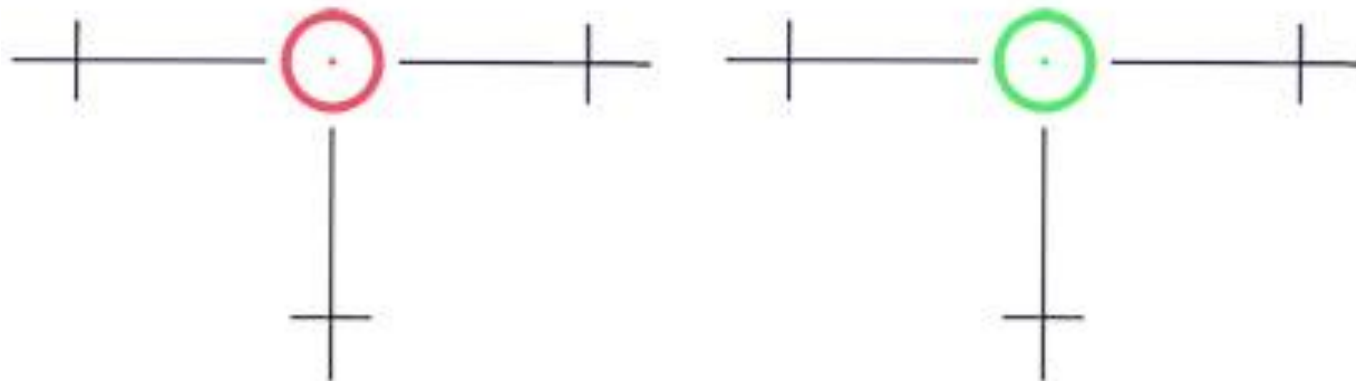
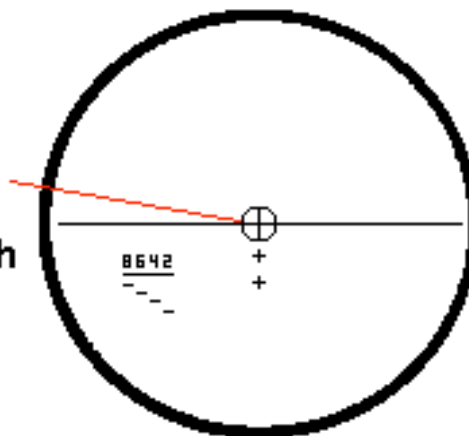

Optisan Momba BDC

# Misc. Reticle Patterns (Burris & Mueller)

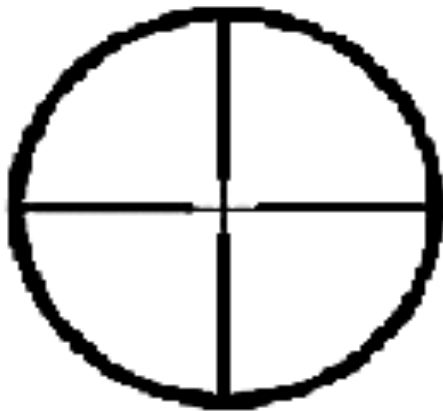

Multi-X Reticle

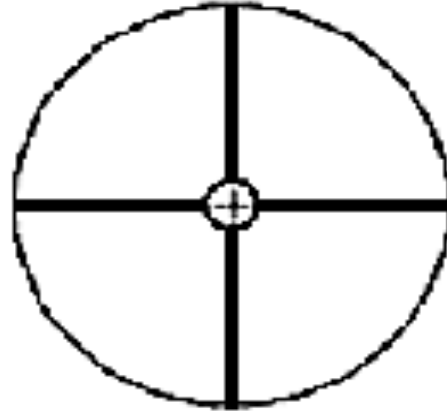

Circle X Reticle

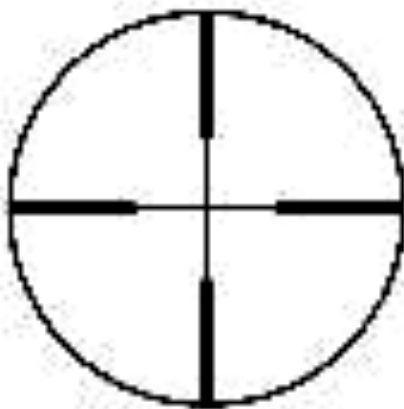

Plex



Mil-Dot

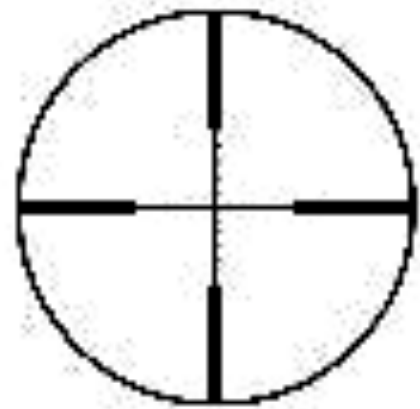

Ballistic Mil-Dot

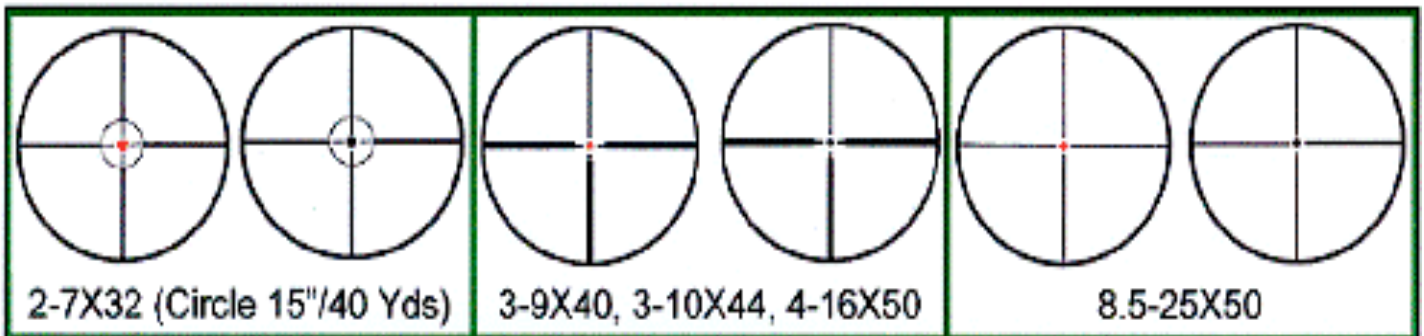

2-7X32 (Circle 15"/40 Yds)

3-9X40, 3-10X44, 4-16X50

8.5-25X50

Scope	Dot Size 100 Yds	Adj. Per Click	Brightness Settings	FOV 100 Yds	Wt. (oz)	Length (inch)	Eye Relief
2-7X32mm Red Dot	1 MOA	1/4"	11	47-18'	13.3	11.3	3.25
3-9X40 Red Dot	1/8 MOA	1/8"	11	39-13'	14	13	3.25"
3-10X44 Red Dot	1/8 MOA	1/8"	11	40.8-12.8'	15.2	13.1	3.25"
4-16X50AO Red Dot	1/8 MOA	1/8"	11	30.6-7.5'	19.7	14.53	3.25"
8.5-25X50mm AO Red Dot	1/16 MOA	1/8"	11	18.8-6.3'	20.8	15.53	3.00"

# Misc. Reticle Patterns (Tasco, Hakko ElectroDot, Weaver)

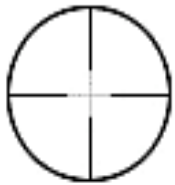

**30/30**



**Stadia**

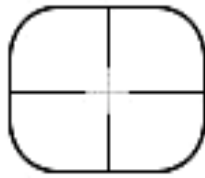

**30/30 TV True MilDot**

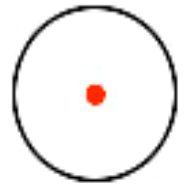
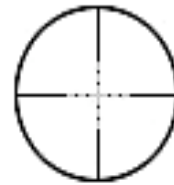

**Red Dot**



## Hakko Multi-Reticle (MR-02 pattern)

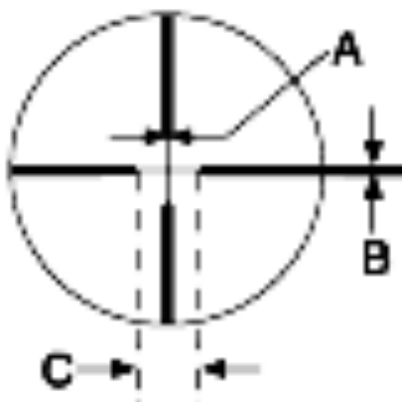

**Weaver Dual-X  
Reticle**

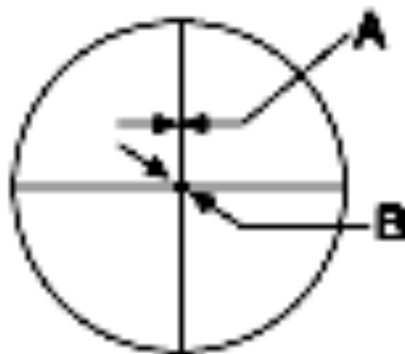

**Weaver DOT  
Reticle**

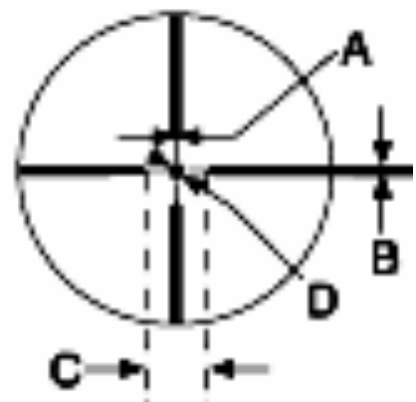

**Weaver  
Varminter  
Reticle**

# Misc. Reticle Patterns (Leatherwood Auto/Range Reticle)

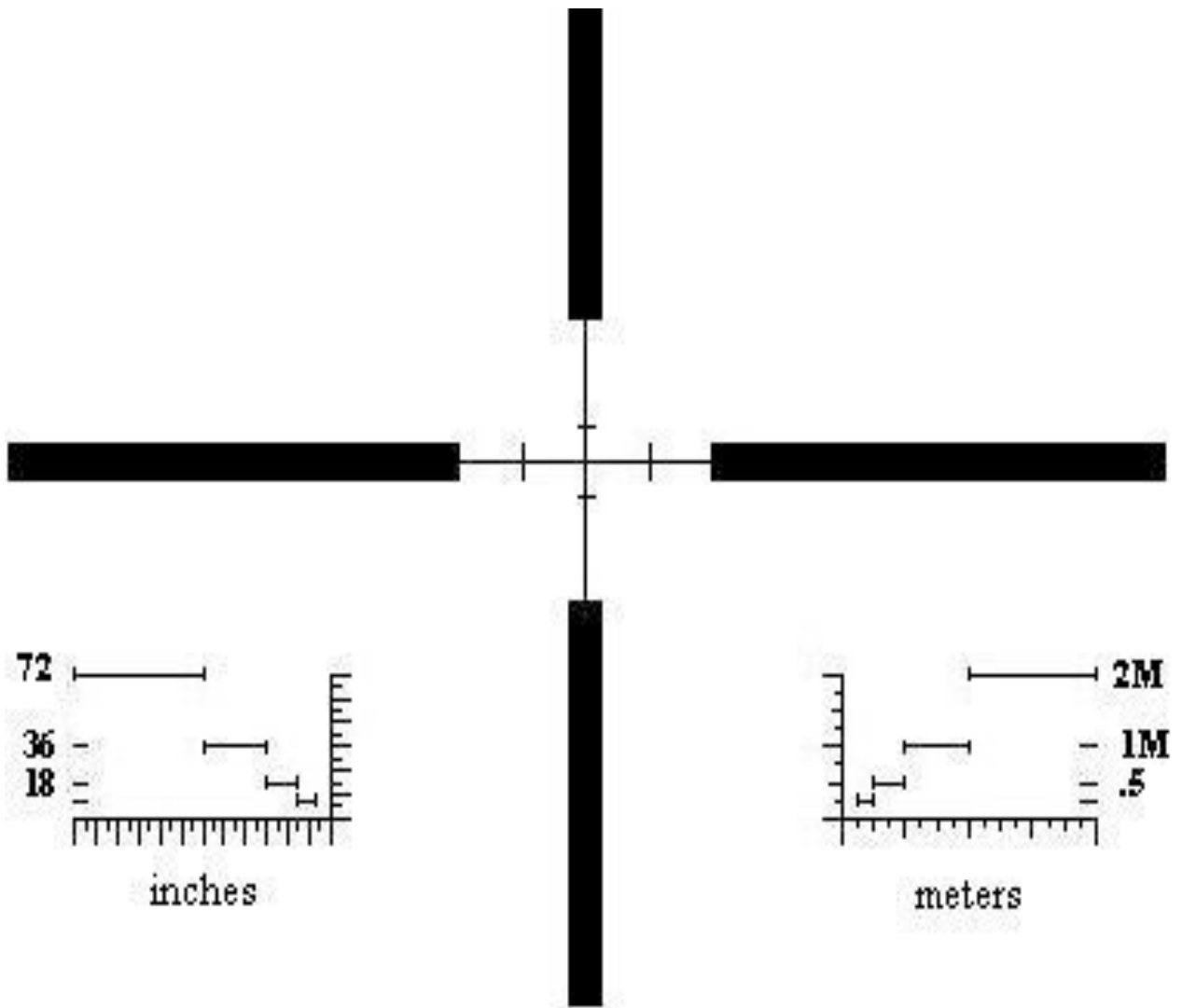

# INFO - US ARMY MILDOT RETICLE

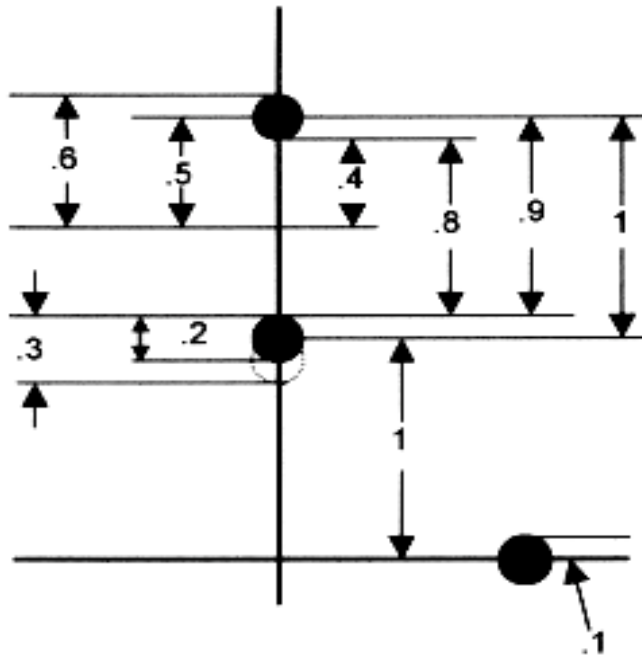

# INFO - USMC MILDOT RETICLE

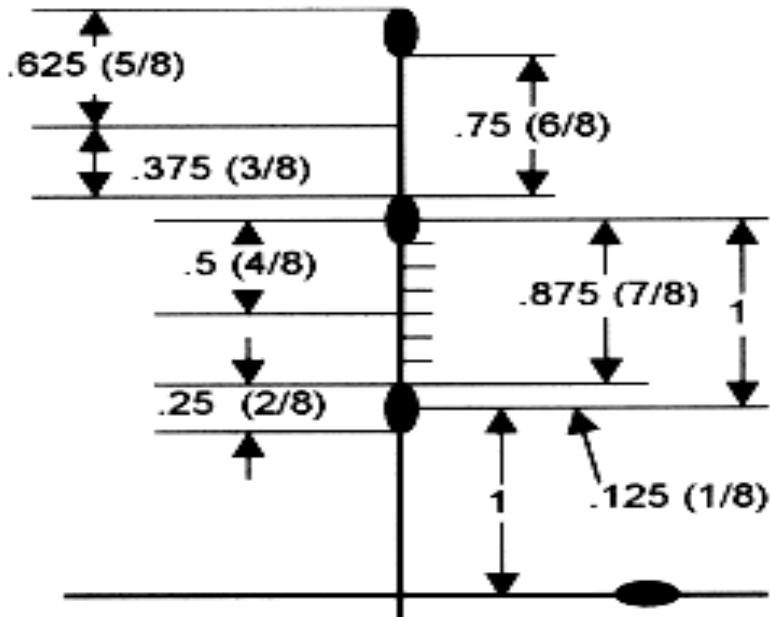



## MIL DOT RETICLE MEASUREMENTS

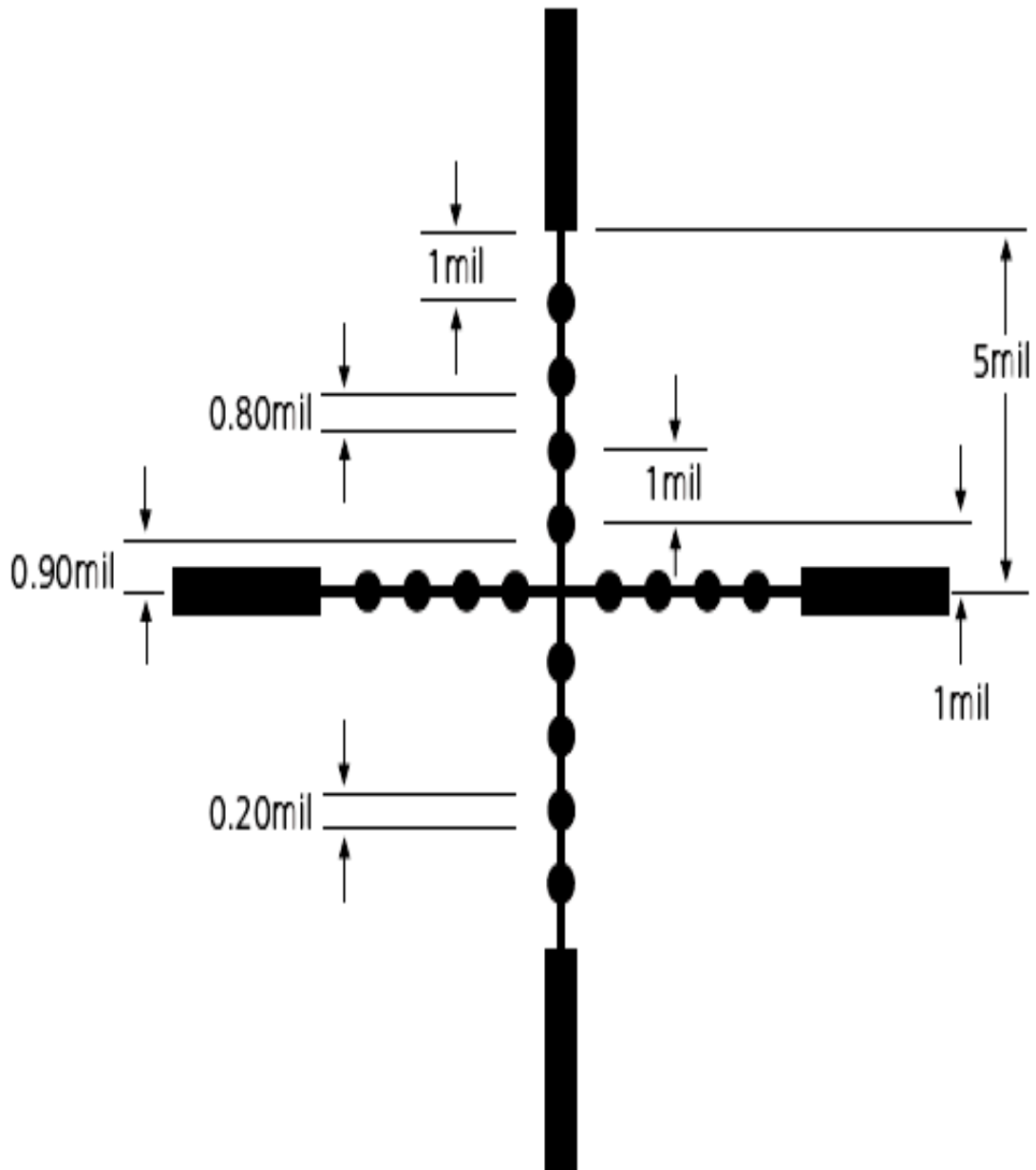

@ 100 YARDS

1 mil = 3.600"  
 0.9 mil = 3.240"  
 0.8 mil = 2.880"

0.5 mil = 1.800"  
 0.2 mil = 0.720"  
 1 mil = 3.438 Minutes of Angle = 3.600"

# MIL DOT RETICLE HOLDOVER CONCEPT

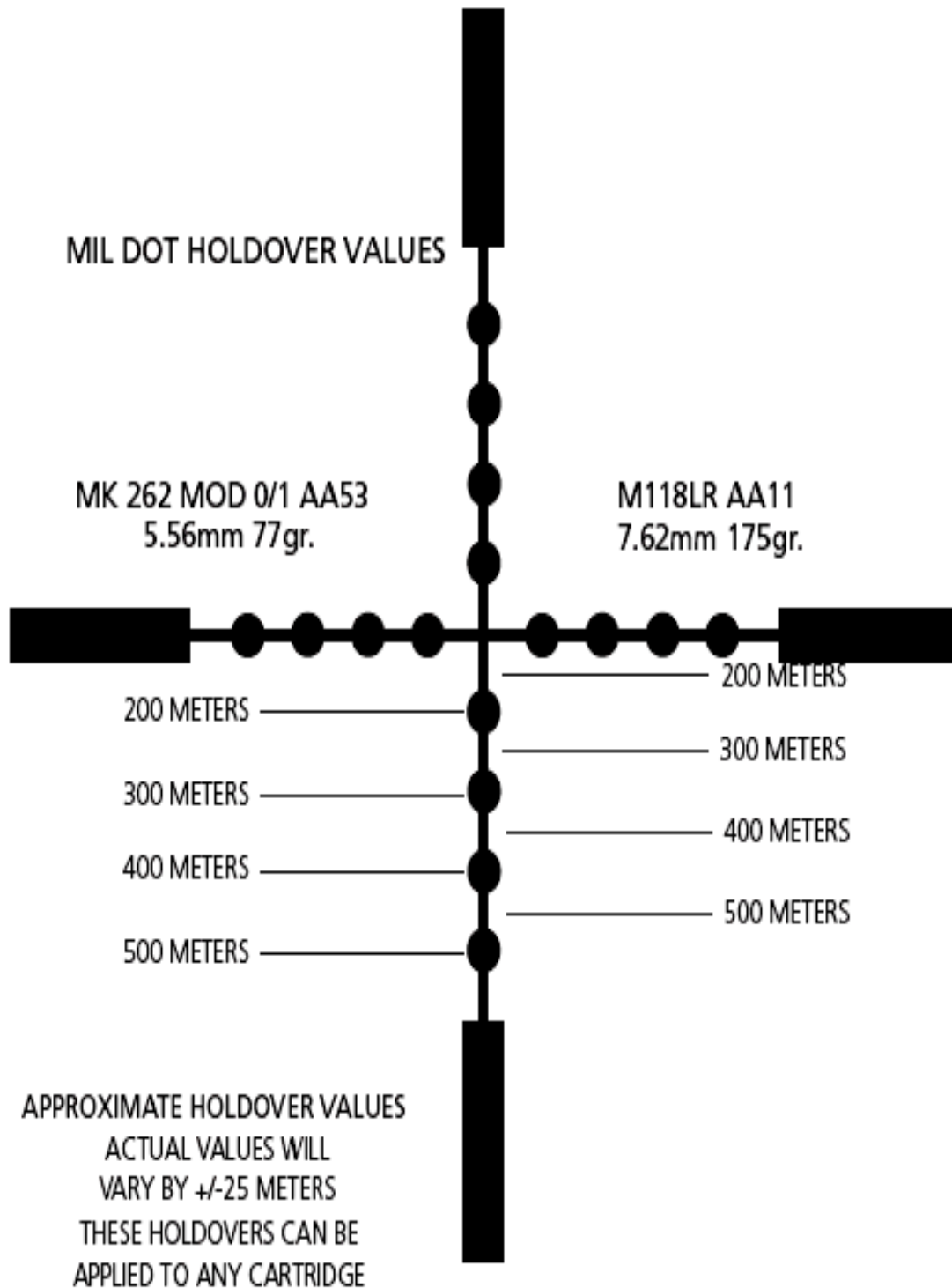

# MIL DOT RETICLE HOLDOVER CONCEPT

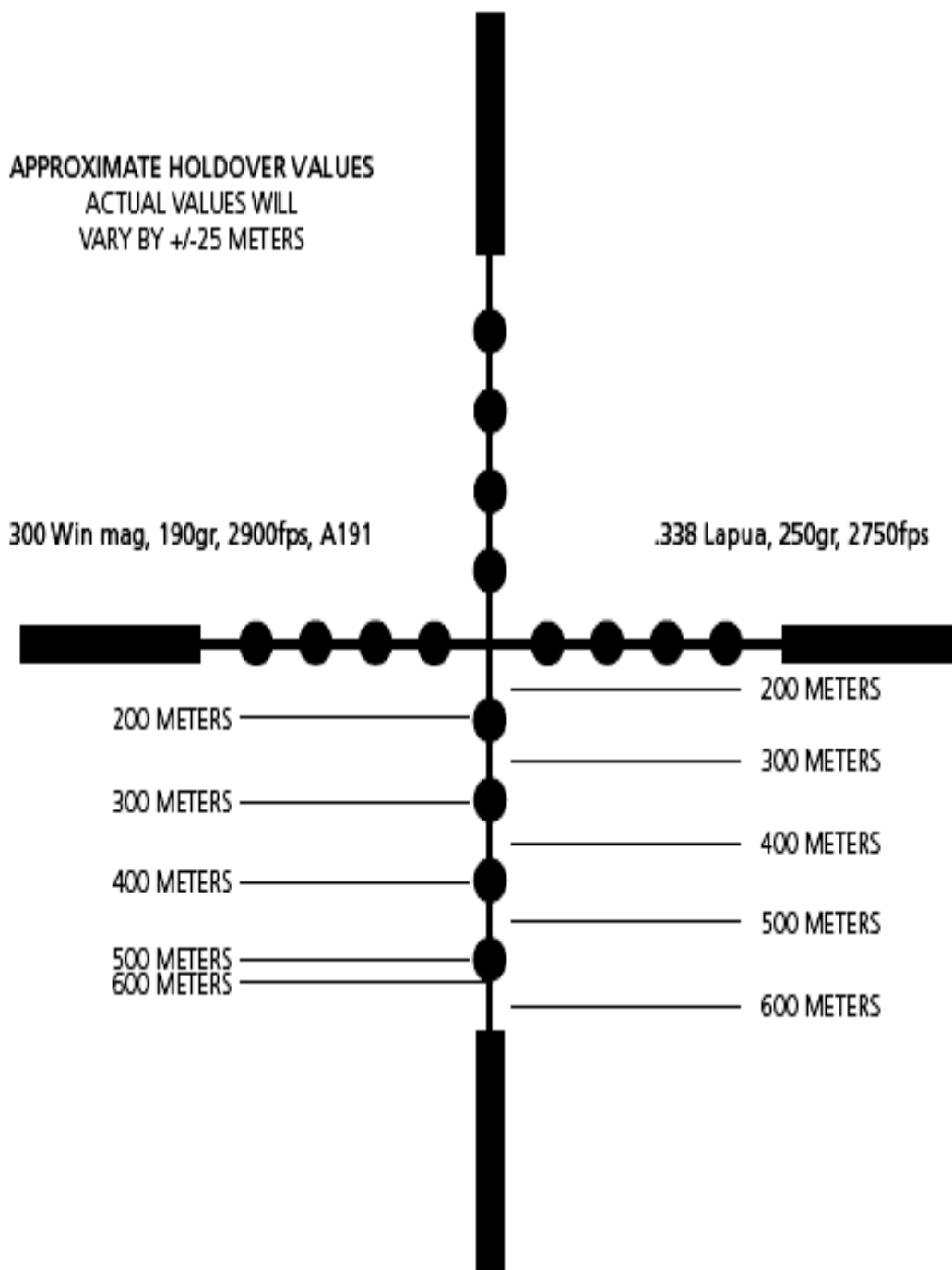

**The Reticle Patterns in this Handbook were generated from the following Original Manufacturer's Web Sites or other electronic media. These images are for educational usage only and not intended for commercial publication, sale or use.**

- **Schmidt and Bender**
- **US Optics**
- **David Tubb/Brand Cole**
- **Premier Reticles**
- **Horus Vision Systems**
- **Hakko**
- **Tasco**
- **Burris**
- **Zeiss Optics**
- **Hensoldt**
- **Mueller**
- **IOR Valdada**
- **Nikon**
- **Weaver**
- **Leupold**
- **Kahles**
- **NightForce**
- **Swarovski**
- **Leatherwood**
- **Pride Fowler**
- **Vortex Razor**
- **Darrell Holland's ART Reticles**
- **Huskemaw Scopes**
- **Super Sniper Scopes**
- **Meopta**
- **Firefield**
- **Optisan**